



Vehicle History Report™

US \$44.99

2011 TOYOTA SIENNA XLE 7-PASSENGER

VIN: 5TDDK3DC1BS020730
VAN
3.5L V6 F DOHC 24V
GASOLINE
ALL WHEEL DRIVE

Accident reported: moderate damage

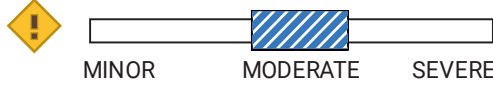

37 Service history records

CARFAX 1-Owner vehicle

Personal vehicle

226,972 Last reported odometer reading

CARFAX Ownership History

The number of owners is estimated

Owner 1

Year purchased

2011

Type of owner

Personal

Estimated length of ownership

12 yrs. 10 mo.

Owned in the following states/provinces

Minnesota

Estimated miles driven per year

18,566/yr

Last reported odometer reading

226,972



CARFAX Title History

CARFAX guarantees the information in this section

Owner 1

Damage Brands

Salvage | Junk | Rebuilt | Fire | Flood | Hail | Lemon

Guaranteed
No Problem

Odometer Brands

Not Actual Mileage | Exceeds Mechanical Limits

Guaranteed
No Problem

CARFAX Additional History

Not all accidents / issues are reported to CARFAX

Owner 1

Total Loss



No total loss reported to CARFAX.

No Issues
Reported

Structural Damage

CARFAX recommends that you have this vehicle inspected by a collision repair specialist.

No Issues
Reported

Airbag Deployment No airbag deployment reported to CARFAX.	 No Issues Reported
Odometer Check No indication of an odometer rollback.	 No Issues Indicated
Accident / Damage Damage reported: 01/02/2018. Accident reported: 06/02/2018.	Accident Reported
Manufacturer Recall No open recalls reported to CARFAX. Check with an authorized Toyota dealer for any open recalls. View Toyota disclosure	 No Recalls Reported
Basic Warranty Original warranty estimated to have expired.	Warranty Expired









Detailed History



Owner 1

Purchased: 2011

Personal Vehicle
18,566 mi/yr

Date	Mileage	Source	Comments
02/14/2011		NICB	Vehicle manufactured and shipped to Minnesota
03/09/2011		Walser Bloomington Toyota Minneapolis, MN 952-236-4745 walsertoyota.com  4.3 / 5.0 1,134 Verified Reviews  23,487 Customer Favorites	 Vehicle serviced - Pre-delivery inspection completed
04/02/2011		Dealer Inventory	Vehicle offered for sale
04/04/2011	60	Rudy Luther's Toyota Minneapolis, MN 763-544-1313 rltoyota.lutherauto.com  4.4 / 5.0 300 Verified Reviews  370 Customer Favorites	Vehicle sold
04/04/2011		Minnesota Motor Vehicle Dept.	Vehicle purchase reported - Titled or registered as personal vehicle
04/18/2011		Minnesota Motor Vehicle Dept. Victoria, MN Title #FL108V226	Title or registration issued - First owner reported - Loan or lien reported - Vehicle color noted as Black
04/22/2011		Rudy Luther's Toyota Minneapolis, MN 763-544-1313 rltoyota.lutherauto.com	 Vehicle serviced - Trim checked

★ 4.4 / 5.0
300 Verified Reviews
♥ 370 Customer Favorites

07/20/2011 4,689

Rudy Luther Toyota Scion
Minneapolis, MN
763-222-2020
rudyluthertoyota.com/

★ 4.4 / 5.0
300 Verified Reviews
♥ 370 Customer Favorites



Vehicle serviced

- Recommended maintenance performed
- Maintenance inspection completed
- Engine checked
- Engine electrical system checked
- Oil and filter changed

10/28/2011

Rudy Luther's Toyota
Minneapolis, MN
763-544-1313
rltoyota.lutherauto.com

★ 4.4 / 5.0
300 Verified Reviews
♥ 370 Customer Favorites



Vehicle serviced

- Maintenance inspection completed
- 10,000 mile service performed
- Oil and filter changed

02/20/2012

Rudy Luther's Toyota
Minneapolis, MN
763-544-1313
rltoyota.lutherauto.com

★ 4.4 / 5.0
300 Verified Reviews
♥ 370 Customer Favorites



Vehicle serviced

- Maintenance inspection completed
- 15,000 mile service performed
- Oil and filter changed

04/04/2012

Minnesota
Motor Vehicle Dept.
Victoria, MN
Title #FL108V226

Registration issued or renewed

- Loan or lien reported
- Vehicle color noted as Black

06/18/2012 18,670

Rudy Luther Toyota Scion
Minneapolis, MN
763-222-2020
rudyluthertoyota.com/

★ 4.4 / 5.0
300 Verified Reviews
♥ 370 Customer Favorites



Vehicle serviced

09/15/2012 23,282

Rudy Luther Toyota Scion
Minneapolis, MN
763-222-2020
rudyluthertoyota.com/

★ 4.4 / 5.0
300 Verified Reviews
♥ 370 Customer Favorites



Vehicle serviced

- Maintenance inspection completed
- Recommended maintenance performed
- Tire condition and pressure checked
- Brakes checked
- Air filter replaced
- Cabin air filter replaced/cleaned
- Oil and filter changed

01/26/2013 28,247







Rudy Luther Toyota Scion
Minneapolis, MN
763-222-2020
rudyluthertoyota.com/

★ 4.4 / 5.0
300 Verified Reviews
♥ 370 Customer Favorites



Vehicle serviced

- Fluids checked
- Oil and filter changed

03/04/2013		Minnesota Motor Vehicle Dept. Victoria, MN Title #FL108V226		Registration issued or renewed - Loan or lien reported - Vehicle color noted as Black
05/31/2013	33,037	Rudy Luther Toyota Scion Minneapolis, MN 763-222-2020 rudyluthertoyota.com/ ★ 4.4 / 5.0 300 Verified Reviews ❤️ 370 Customer Favorites		Vehicle serviced - Fluids checked - Oil and filter changed
03/05/2014		Minnesota Motor Vehicle Dept. Victoria, MN Title #FL108V226		Registration issued or renewed - Loan or lien reported - Vehicle color noted as Black
04/22/2015		Minnesota Motor Vehicle Dept. Victoria, MN Title #FL108V226		Registration issued or renewed - Loan or lien reported - Vehicle color noted as Black
07/23/2015		National Tire & Battery Chaska, MN 952-448-2091 ntb.com		Vehicle serviced - Tire condition and pressure checked - Tires rotated - Oil and filter changed - Tire(s) balanced
11/01/2015		National Tire & Battery Chaska, MN 952-448-2091 ntb.com		Vehicle serviced - Tire condition and pressure checked - Oil and filter changed - Tires rotated - Tire(s) balanced
03/03/2016		Minnesota Motor Vehicle Dept. Victoria, MN Title #FL108V226		Registration issued or renewed - Loan or lien reported - Vehicle color noted as Black
05/08/2016		National Tire & Battery Chaska, MN 952-448-2091 ntb.com		Vehicle serviced - Tire condition and pressure checked - Tires rotated - Oil and filter changed - Air filter replaced
07/16/2016		National Tire & Battery Chaska, MN 952-448-2091 ntb.com		Vehicle serviced - Tire condition and pressure checked - Tires rotated - Oil and filter changed
10/08/2016		National Tire & Battery Chaska, MN 952-448-2091 ntb.com		Vehicle serviced - Alignment performed - Tire condition and pressure checked - Oil and filter changed - Tires rotated
12/29/2016		National Tire & Battery Chaska, MN 952-448-2091		Vehicle serviced - Tire condition and pressure checked - Oil and filter changed

ntb.com

- Battery/charging system checked
- Tires rotated

03/07/2017

Minnesota
 Motor Vehicle Dept.
 Victoria, MN
 Title #FL108V226

Registration issued or renewed

- Loan or lien reported
- Vehicle color noted as Black

04/03/2017

National Tire & Battery
 Chaska, MN
 952-448-2091
 ntb.com



Vehicle serviced

- Tire condition and pressure checked
- Oil and filter changed
- Battery/charging system checked
- Air filter replaced
- Tires rotated
- Alignment performed

06/21/2017

National Tire & Battery
 Chaska, MN
 952-448-2091
 ntb.com



Vehicle serviced

- Alignment performed
- Tire condition and pressure checked
- Oil and filter changed
- Tires rotated
- Battery/charging system checked

08/15/2017

National Tire & Battery
 Chaska, MN
 952-448-2091
 ntb.com



Vehicle serviced

- Tire condition and pressure checked
- Battery/charging system checked
- Oil and filter changed
- Tires rotated

11/11/2017

National Tire & Battery
 Chaska, MN
 952-448-2091
 ntb.com



Vehicle serviced

- Tire condition and pressure checked
- Tires rotated
- Oil and filter changed
- Battery/charging system checked

01/02/2018

Damage Report



Damage reported: minor damage

- Damage to rear

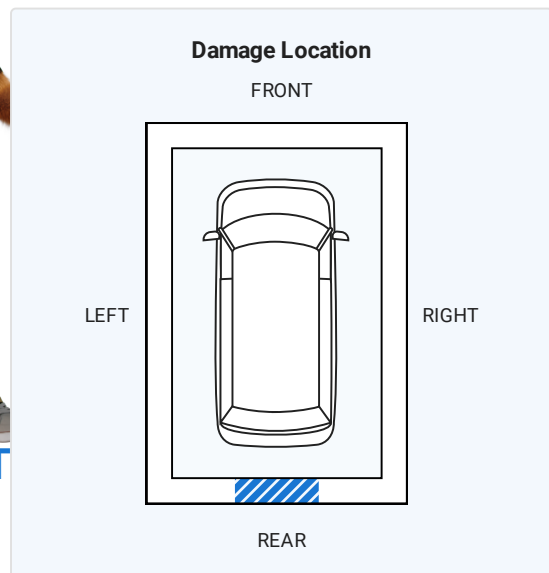
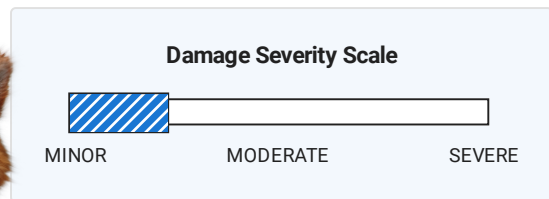

**CARFAX HAS THE MOST
 ACCIDENT & DAMAGE
 INFORMATION**

03/06/2018

Minnesota
Motor Vehicle Dept.
Victoria, MN
Title #FL108V226

Title or registration issued
- Loan or lien reported
- Vehicle color noted as Black

06/02/2018

Damage Report



Accident reported: moderate damage with another motor vehicle
- Damage to rear
- Damage to front
- Airbags did not deploy



CARFAX HAS THE MOST ACCIDENT & DAMAGE INFORMATION

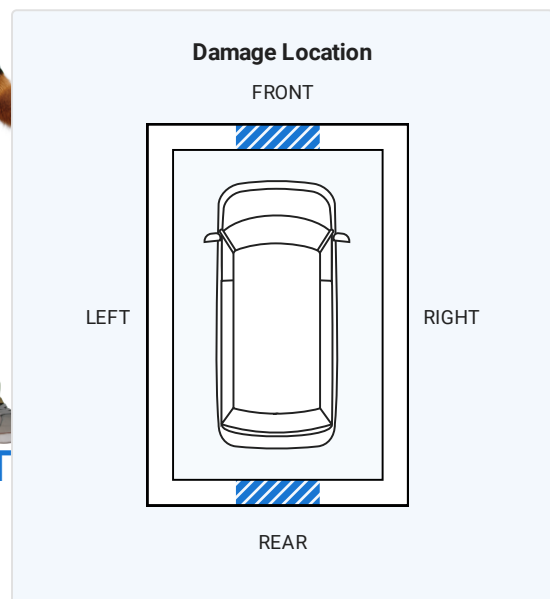
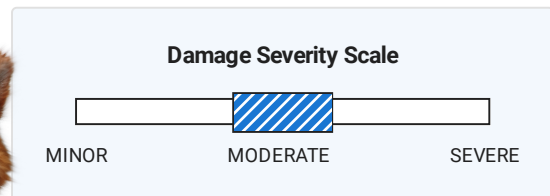

09/17/2018

130,221

Big O Tires
Chaska, MN
952-448-2091
bigotires.com
★ 4.4 / 5.0
18 Verified Reviews
❤️ 9 Customer Favorites



Vehicle serviced
- Tire(s) replaced

03/06/2019

Minnesota
Motor Vehicle Dept.
Victoria, MN
Title #FL108V226

Title or registration issued
- Loan or lien reported
- Vehicle color noted as Black

05/26/2019

154,814

Big O Tires
Chaska, MN
952-448-2091
bigotires.com
★ 4.4 / 5.0
18 Verified Reviews
❤️ 9 Customer Favorites



Vehicle serviced
- Oil and filter changed

08/13/2019

160,702

Big O Tires

Vehicle serviced

Chaska, MN
952-448-2091
bigotires.com

★ 4.4 / 5.0

18 Verified Reviews

♥ 9 Customer Favorites



- Oil and filter changed

02/05/2020 169,279

Rudy Luther Toyota Scion
Minneapolis, MN
763-222-2020
rudyluthertoyota.com/

★ 4.4 / 5.0

300 Verified Reviews

♥ 370 Customer Favorites



Vehicle serviced

- Battery/charging system checked
- Sliding door checked

03/07/2020 170,832

Big O Tires
Chaska, MN
952-448-2091
bigotires.com

★ 4.4 / 5.0

18 Verified Reviews

♥ 9 Customer Favorites



Vehicle serviced

- Oil and filter changed

03/26/2020

Minnesota
Motor Vehicle Dept.
Victoria, MN
Title #FL108V226

Title or registration issued

- Loan or lien reported
- Vehicle color noted as Black

10/15/2020 180,943

Big O Tires
Chaska, MN
952-448-2091
bigotires.com

★ 4.4 / 5.0

18 Verified Reviews

♥ 9 Customer Favorites



Vehicle serviced

- Oil and filter changed

03/01/2021 185,744

TGK Automotive
Chaska, MN
952-368-5000
<https://tgkauto.com/location-chanhassen/>

★ 4.8 / 5.0

194 Verified Reviews

♥ 1,648 Customer Favorites



Vehicle serviced

- Air filter replaced
- Oil and filter changed
- Tires rotated

03/18/2021

Minnesota
Motor Vehicle Dept.
Victoria, MN
Title #FL108V226

Title or registration issued

- Loan or lien reported
- Vehicle color noted as Black

04/02/2021 187,372

TGK Automotive
Chaska, MN
952-368-5000
<https://tgkauto.com/location-chanhassen/>

★ 4.8 / 5.0

194 Verified Reviews



Vehicle serviced

- Drive belts checked
- Alternator checked

 **1,648** Customer Favorites

06/14/2021 190,710

TGK Automotive
Chaska, MN
952-368-5000
<https://tgkauto.com/location-chanhassen/>

 **4.8 / 5.0**

194 Verified Reviews

 **1,648** Customer Favorites



Vehicle serviced
- Oil and filter changed

07/26/2021 193,161

TGK Automotive
Chaska, MN
952-368-5000
<https://tgkauto.com/location-chanhassen/>

 **4.8 / 5.0**

194 Verified Reviews

 **1,648** Customer Favorites



Vehicle serviced

09/11/2021 195,315

Valvoline Instant Oil Change
Shorewood, MN
952-474-0450
vioc.com

 **4.5 / 5.0**

115 Verified Reviews

 **135** Customer Favorites



Vehicle serviced
- Oil and filter changed
- Tires rotated
- Cabin air filter replaced/cleaned

12/22/2021 200,541

TGK Automotive
Chaska, MN
952-368-5000
<https://tgkauto.com/location-chanhassen/>

 **4.8 / 5.0**

194 Verified Reviews

 **1,648** Customer Favorites



Vehicle serviced
- Oil pan drain plug replaced
- Oil and filter changed

02/27/2022

Minnesota
Motor Vehicle Dept.
Victoria, MN
Title #FL108V226

Title issued or updated
- Registration issued or renewed
- Loan or lien reported
- Vehicle color noted as Black

04/01/2022 205,821

TGK Automotive
Chaska, MN
952-368-5000
<https://tgkauto.com/location-chanhassen/>

 **4.8 / 5.0**

194 Verified Reviews

 **1,648** Customer Favorites



Vehicle serviced
- Oil and filter changed

06/27/2022 211,240

TGK Automotive
Chaska, MN
952-368-5000
<https://tgkauto.com/location-chanhassen/>

 **4.8 / 5.0**



Vehicle serviced
- Oil and filter changed

194 Verified Reviews

 **1,648** Customer Favorites

08/15/2022 214,464

TGK Automotive
Chaska, MN
952-368-5000
<https://tgkauto.com/location-CHANHASSEN/>

 **4.8 / 5.0**

194 Verified Reviews

 **1,648** Customer Favorites



Vehicle serviced

- Four tires balanced

09/26/2022 216,452

TGK Automotive
Chaska, MN
952-368-5000
<https://tgkauto.com/location-CHANHASSEN/>

 **4.8 / 5.0**

194 Verified Reviews

 **1,648** Customer Favorites



Vehicle serviced

- Oil and filter changed

- Tires rotated

01/16/2023 221,604

TGK Automotive
Chaska, MN
952-368-5000
<https://tgkauto.com/location-CHANHASSEN/>

 **4.8 / 5.0**

194 Verified Reviews

 **1,648** Customer Favorites



Vehicle serviced

- Oil and filter changed

03/23/2023

Minnesota
Motor Vehicle Dept.
Victoria, MN
Title #FL108V226

Title issued or updated

- Registration issued or renewed

- Loan or lien reported

- Vehicle color noted as Black

06/22/2023 226,972

TGK Automotive -
Chanhassen
Chaska, MN
952-368-5000
tgkauto.com/locations/CHANHASSEN/

 **4.8 / 5.0**

194 Verified Reviews

 **1,648** Customer Favorites



Vehicle serviced

- Maintenance inspection completed

- Oil and filter changed

- Lug nut(s)/bolt(s) replaced

- Tires rotated

- Brakes checked

- Tire condition and pressure checked

02/26/2024

Minnesota
Motor Vehicle Dept.
Victoria, MN
Title #FL108V226

Title issued or updated

- Registration issued or renewed

- Loan or lien reported

- Vehicle color noted as Black



Avoid financial headaches. Make sure the loan has been paid off if you're buying from a private seller.
[Learn More](#)

02/29/2024

Online Listing

Vehicle offered for sale



Accident Indicator

CARFAX receives information about accidents in all 50 states, the District of Columbia and Canada.

Not every accident is reported to CARFAX. As details about the accident become available, those additional details are added to the CARFAX Vehicle History Report. CARFAX recommends that you have this vehicle inspected by a qualified mechanic.

Damage Indicator

Damage can be a result of many different types of events. Examples include contact with objects (other cars, trees, traffic signs, road debris, etc), vandalism, or weather-related events. Not every damage event is reported to CARFAX. As details about the damage event become available, those additional details are added to the CARFAX Vehicle History Report. CARFAX recommends that you have this vehicle inspected by a qualified mechanic.

Damage Severity

Damage events result in one of the following severity levels:

- **Minor:** Generally, minor damage is cosmetic (including dents or scratches), may only require reconditioning, and typically does not compromise a vehicle's operation and/or safety.
- **Moderate:** Moderate damage may affect multiple components of the vehicle and may impair the vehicle's operation and/or safety.
- **Severe:** Severe damage usually affects multiple components of the vehicle and is likely to compromise the vehicle's operation and/or safety.

CARFAX recommends getting a pre-purchase inspection at a certified collision repair facility.

First Owner

When the first owner(s) obtains a title from a Department of Motor Vehicles as proof of ownership.

Ownership History

CARFAX defines an owner as an individual or business that possesses and uses a vehicle. Not all title transactions represent changes in ownership. To provide estimated number of owners, CARFAX proprietary technology analyzes all the events in a vehicle history. Estimated ownership is available for vehicles manufactured after 1991 and titled solely in the US including Puerto Rico. Dealers sometimes opt to take ownership of a vehicle and are required to in the following states: Maine, Massachusetts, New Jersey, Ohio, Oklahoma, Pennsylvania and South Dakota. Please consider this as you review a vehicle's estimated ownership history.

Title Issued

A state issues a title to provide a vehicle owner with proof of ownership. Each title has a unique number. Each title or registration record on a CARFAX report does not necessarily indicate a change in ownership. In Canada, a registration and bill of sale are used as proof of ownership.

Toyota Recall / Service Campaign

Portions of this report have been included under license from Toyota Motor North America, Inc. ("TOYOTA"), License Agreement TMS1013. This data applies only to vehicle marketed or originally sold in Mexico and the United States of America, including Guam, Saipan, American Samoa, Puerto Rico, the U.S. Virgin Islands and the other United States territories and protectorates with currently open safety or emissions recalls, or service campaigns. While TOYOTA provides data to Carfax Inc. on a regular basis, this report may not include very recent activity. For the manufacturer's most current information on recall/campaign activity for any Toyota, Lexus or Scion brand vehicle, you must go to <http://toyota.com/recall> or <http://lexus.com/recall>.