



Vehicle History Report™

US \$44.99

2013 AUDI Q7 3.0 QUATTRO TDI PRESTIGE

VIN: WA1WMAFE8DD008816
4 DOOR WAGON/SPORT UTILITY
3.0L V6 F DOHC 24V
DIESEL
ALL WHEEL DRIVE

 Accident reported

 **23** Service history records

 At least 1 open recall

 **2** Previous owners

 Personal vehicle

 **87,061** Last reported odometer reading



Ownership History

The number of owners is estimated

Owner 1

Owner 2

Year purchased

2013

2020

Type of owner

Personal

Personal

Estimated length of ownership

7 yrs. 1 mo.

3 yrs. 1 mo.

Owned in the following states/provinces

New York, Michigan

Iowa

Estimated miles driven per year

7,008/yr

11,834/yr

Last reported odometer reading

49,901

87,061



Title History

CARFAX guarantees the information in this section

Owner 1

Owner 2

Damage Brands

Salvage | Junk | Rebuilt | Fire | Flood | Hail | Lemon

 **Guaranteed**
No Problem

 **Guaranteed**
No Problem

Odometer Brands

Not Actual Mileage | Exceeds Mechanical Limits

 **Guaranteed**
No Problem

 **Guaranteed**
No Problem



Additional History

Not all accidents / issues are reported to CARFAX

Owner 1

Owner 2

Total Loss

No total loss reported to CARFAX.

 No Issues
Reported

 No Issues
Reported

Structural Damage

CARFAX recommends that you have this vehicle inspected by a collision

 No Issues
Reported

 No Issues
Reported

repair specialist.		
Airbag Deployment No airbag deployment reported to CARFAX.	✓ No Issues Reported	✓ No Issues Reported
Odometer Check No indication of an odometer rollback.	✓ No Issues Indicated	✓ No Issues Indicated
Accident / Damage Accidents reported: 06/20/2013 and 06/21/2018. Damage reported: 09/20/2013.	Accident Reported	No New Issues Reported
Manufacturer Recall At least 1 manufacturer recall requires service. Locate an authorized Audi dealer to obtain more information about this recall.	✓ No Recalls Reported	Recall Reported
Basic Warranty Original warranty estimated to have expired.	Warranty Expired	Warranty Expired



Detailed History



Owner 1

Purchased: 2013



Low mileage! This owner drove less than the industry average of 15,000 miles per year.

Personal Vehicle
7,008 mi/yr

Date	Mileage	Source	Comments
Not Reported		NICB	Vehicle manufactured and shipped to Connecticut
12/31/2012	13	New Country Audi Greenwich, CT 203-661-1800 newcountryaudi.com ★ 4.6 / 5.0 117 Verified Reviews ♥ 155 Customer Favorites	Vehicle offered for sale
01/02/2013		New Country Audi Greenwich, CT 203-661-1800 newcountryaudi.com ★ 4.6 / 5.0 117 Verified Reviews ♥ 155 Customer Favorites	 Vehicle serviced - Pre-delivery inspection completed - Tire(s) changed
01/04/2013		New Country Audi Greenwich, CT 203-661-1800 newcountryaudi.com ★ 4.6 / 5.0 117 Verified Reviews ♥ 155 Customer Favorites	Vehicle sold
01/10/2013		New York	Registration issued or renewed

Motor Vehicle Dept.
Albany, NY

- Titled or registered as personal vehicle
- Passed safety inspection

01/17/2013 441

New York
Inspection Station

Passed safety inspection
- Emissions inspection performed

01/31/2013

New York
Motor Vehicle Dept.
Albany, NY

Title issued or updated
- First owner reported

06/20/2013

Damage Report



Accident reported with another motor vehicle

09/12/2013

Northway Toyota
Latham, NY
518-783-1951
langanauto.com



Vehicle serviced

★ 4.7 / 5.0
19 Verified Reviews

09/12/2013

Langan Audi East
Latham, NY
518-783-5003
langanaudi east.com



Vehicle serviced
- 5,000 mile service performed

★ 4.9 / 5.0
16 Verified Reviews

09/20/2013

Damage Report



Damage reported: minor damage
- Damage to rear



**CARFAX HAS THE MOST
ACCIDENT & DAMAGE
INFORMATION**

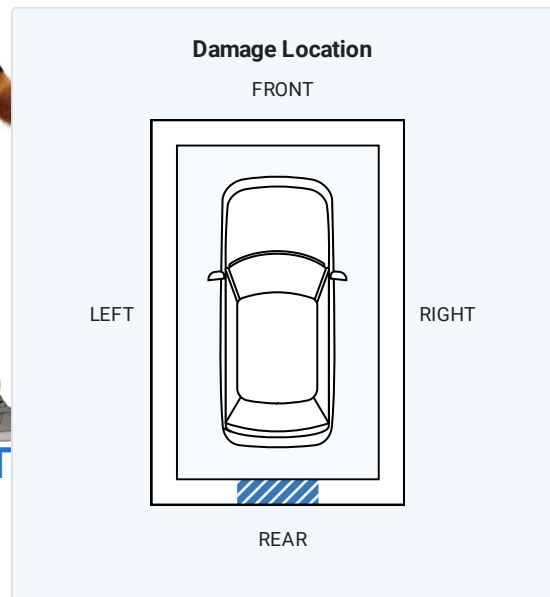
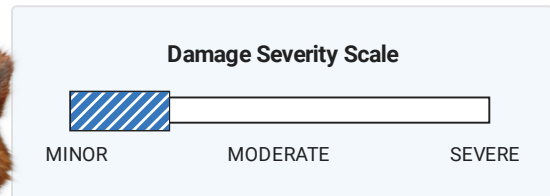

09/30/2013 5,001

Northway Toyota
Latham, NY
518-783-1951
langanauto.com



Vehicle serviced

★ 4.7 / 5.0

19 Verified Reviews

10/09/2013

Langan Audi East
Latham, NY
518-783-5003
langanaudi east.com



Vehicle serviced
- Wheel(s) repaired

★ 4.9 / 5.0

16 Verified Reviews

03/17/2014

8,723

New York
Inspection Station

Passed safety inspection
- Emissions inspection performed

09/15/2014

13,039

Langan Audi East
Latham, NY
518-783-5003
langanaudi east.com



Vehicle serviced
- 15,000 mile service performed
- Anti-theft/keyless remote battery replaced
- Tires rotated

★ 4.9 / 5.0

16 Verified Reviews

10/01/2014

13,394

Langan Audi East
Latham, NY
518-783-5003
langanaudi east.com



Vehicle serviced

★ 4.9 / 5.0

16 Verified Reviews

11/23/2014

New York
Motor Vehicle Dept.
Albany, NY

Registration issued or renewed
- Titled or registered as personal vehicle
- Passed safety inspection

06/15/2015

18,608

New York
Inspection Station

Passed safety inspection
- Passed emissions inspection

08/14/2015

20,484

Langan Audi East
Latham, NY
518-783-5003
langanaudi east.com



Vehicle serviced

★ 4.9 / 5.0

16 Verified Reviews

09/10/2015

25,260

Langan Audi East
Latham, NY
518-783-5003
langanaudi east.com



Vehicle serviced
- Maintenance inspection completed
- 25,000 mile service performed
- Wheel(s) repaired
- Brake fluid flushed/changed
- Radio/sound system repaired

★ 4.9 / 5.0

16 Verified Reviews

05/17/2016

25,431

Audi Albany
Latham, NY
518-783-5003
audialbany.com/



Vehicle serviced
- Drivability/performance checked

★ 4.5 / 5.0

124 Verified Reviews

♥ 7 Customer Favorites

06/25/2016

26,036

Audi Albany
Latham, NY
518-783-5003
audialbany.com/



Vehicle serviced

★ 4.5 / 5.0
124 Verified Reviews
❤️ 7 Customer Favorites

06/28/2016 26,061 New York Inspection Station **Passed safety inspection**
- Passed emissions inspection

07/16/2016 26,541 Audi Albany Latham, NY 518-783-5003 audialbany.com/  **Vehicle serviced**
★ 4.5 / 5.0
124 Verified Reviews
❤️ 7 Customer Favorites

08/06/2016 Audi Albany Latham, NY 518-783-5003 audialbany.com/  **Vehicle serviced**
★ 4.5 / 5.0
124 Verified Reviews
❤️ 7 Customer Favorites

10/18/2016 28,207 Audi Albany Latham, NY 518-783-5003 audialbany.com/  **Vehicle serviced**
- 25,000 mile service performed
- Wheel(s) repaired
★ 4.5 / 5.0
124 Verified Reviews
❤️ 7 Customer Favorites

12/06/2016 New York Motor Vehicle Dept. Albany, NY **Registration issued or renewed**
- Titled or registered as personal vehicle
- Passed safety inspection

12/21/2016 29,795 Audi Albany Latham, NY 518-783-5003 audialbany.com/  **Vehicle serviced**
★ 4.5 / 5.0
124 Verified Reviews
❤️ 7 Customer Favorites

02/10/2017 30,148 Audi Albany Latham, NY 518-783-5003 audialbany.com/  **Vehicle serviced**
- Drivability/performance checked
★ 4.5 / 5.0
124 Verified Reviews
❤️ 7 Customer Favorites

06/17/2017 32,643 New York Inspection Station **Passed safety inspection**
- Passed emissions inspection

09/22/2017 35,117 Audi Albany Latham, NY 518-783-5003 audialbany.com/  **Vehicle serviced**
- One tire mounted
- One tire balanced
Tire(s) replaced

audialbany.com/

★ 4.5 / 5.0

124 Verified Reviews

♥ 7 Customer Favorites

Tire(s) replaced
- Tire(s) balanced

10/03/2017

Audi Albany
Latham, NY
518-783-5003
audialbany.com/

★ 4.5 / 5.0

124 Verified Reviews

♥ 7 Customer Favorites



Vehicle serviced
- 35,000 mile service performed
- Two tires mounted
- Two tires balanced
- Sunroof serviced

12/27/2017

Audi Albany
Latham, NY
518-783-5003
audialbany.com/

★ 4.5 / 5.0

124 Verified Reviews

♥ 7 Customer Favorites



Vehicle serviced
- Wheel(s) replaced

06/21/2018

Damage Report



Accident reported: minor damage with another motor vehicle
- Damage to rear



CARFAX HAS THE MOST ACCIDENT & DAMAGE INFORMATION

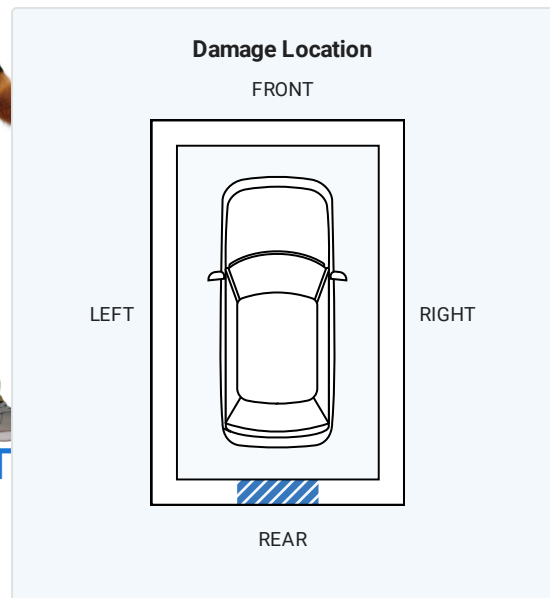
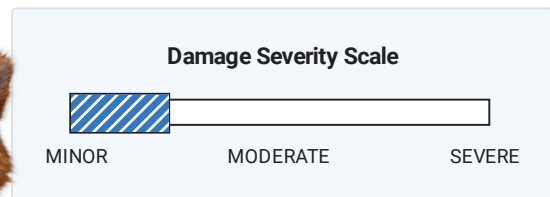

06/29/2018

38,187

Autobahn Centre
Albany, NY
518-689-3086
autobahncentre.com/

★ 4.9 / 5.0

14 Verified Reviews

♥ 14 Customer Favorites



Vehicle serviced
- Oil and filter changed
- Emissions or safety inspection performed

06/29/2018

New York

Passed safety inspection

08/27/2019

New York
Inspection Station

- Passed safety inspection
- Passed emissions inspection

09/20/2018 38,850

Audi Albany
Latham, NY
518-783-5003
audialbany.com/



Vehicle serviced
- Headlight bulb(s) replaced

★ 4.5 / 5.0
124 Verified Reviews
♥ 7 Customer Favorites

02/05/2019

New York
Motor Vehicle Dept.
Albany, NY

Registration issued or renewed
- Titled or registered as personal vehicle
- Passed safety inspection
- Registration updated when owner moved the vehicle to a new location

07/03/2019 44,820

New York
Inspection Station

Passed safety inspection
- Passed emissions inspection

02/17/2020 49,811

Auto Auction

Listed as a dealer vehicle
- Vehicle sold



Millions of used vehicles are bought and sold at auction every year.

02/20/2020

Michigan
Motor Vehicle Dept.

Vehicle purchase reported

02/25/2020

Michigan
Motor Vehicle Dept.
Holland, MI
Title #MI0004669977

Title issued or updated
- Dealer took title of this vehicle while it was in inventory

04/16/2020 49,901

European Autohaus
Holland, MI

Vehicle offered for sale

★ 3.9 / 5.0
15 Verified Reviews

Owner 2
Purchased: 2020



Low mileage! This owner drove less than the industry average of 15,000 miles per year.

Personal Vehicle
11,834 mi/yr

Date Mileage Source Comments

08/24/2020 49,928

Iowa
Motor Vehicle Dept.
Glenwood, IA
Title #65AA96693

Title or registration issued
- New owner reported
- Vehicle color noted as Black



02/01/2021 61,495

Insta-Lube
Omaha, NE
402-553-6851



Vehicle serviced
- Oil and filter changed

★ 4.9 / 5.0
48 Verified Reviews
♥ 6 Customer Favorites

10/12/2021		Iowa Motor Vehicle Dept. Glenwood, IA Title #65AA96693	Registration issued or renewed - Vehicle color noted as Black
04/18/2022		Iowa Motor Vehicle Dept. Glenwood, IA Title #65AA96693	Registration issued or renewed - Vehicle color noted as Black
02/23/2023		Audi	Manufacturer Compliance Recall issued - NHTSA #23V086 - Recall #50G5 SAFETY CERTIFICATION LABEL - Status: Remedy Available - Locate an authorized Audi dealer to obtain more information about this recall ⊕ Learn more about this recall
09/27/2023		Iowa Motor Vehicle Dept. Glenwood, IA Title #65AA96693	Registration issued or renewed - Vehicle color noted as Black
10/13/2023	87,054	Karl Chevrolet of Stuart Stuart, IA 515-523-1201 karlchevroletstuart.com/ ★ 4.6 / 5.0 40 Verified Reviews ❤️ 5 Customer Favorites	Vehicle offered for sale
10/20/2023		Online Listing	Vehicle offered for sale
10/23/2023	87,061	Karl Chevrolet of Stuart Stuart, IA 515-523-1201 karlchevroletstuart.com/ ★ 4.6 / 5.0 40 Verified Reviews ❤️ 5 Customer Favorites	 Vehicle serviced - Wipers/washers checked - Cabin air filter replaced/cleaned - Tire(s) balanced - Air filter replaced - Tires rotated
			Looks like this dealer serviced the car in order to prepare it for sale. That's a good thing!
10/24/2023		Karl Chevrolet of Stuart Stuart, IA 515-523-1201 karlchevroletstuart.com/ ★ 4.6 / 5.0 40 Verified Reviews ❤️ 5 Customer Favorites	Vehicle sold

Accident Indicator

CARFAX receives information about accidents in all 50 states, the District of Columbia and Canada.

Not every accident is reported to CARFAX. As details about the accident become available, those additional details are added to the CARFAX Vehicle History Report. CARFAX recommends that you have this vehicle inspected by a qualified mechanic.

Damage Indicator

Damage can be a result of many different types of events. Examples include contact with objects (other cars, trees, traffic signs, road debris, etc), vandalism, or weather-related events. Not every damage event is reported to CARFAX. As details about the damage event become available, those additional details are added to the CARFAX Vehicle History Report. CARFAX recommends that you have this vehicle inspected by a qualified mechanic.

Damage Severity

Damage events result in one of the following severity levels:

- **Minor:** Generally, minor damage is cosmetic (including dents or scratches), may only require reconditioning, and typically does not compromise a vehicle's operation and/or safety.
- **Moderate:** Moderate damage may affect multiple components of the vehicle and may impair the vehicle's operation and/or safety.
- **Severe:** Severe damage usually affects multiple components of the vehicle and is likely to compromise the vehicle's operation and/or safety.

CARFAX recommends getting a pre-purchase inspection at a certified collision repair facility.

First Owner

When the first owner(s) obtains a title from a Department of Motor Vehicles as proof of ownership.

Manufacturer Recall

Automobile manufacturers issue recall notices to inform vehicle owners of a safety defect or failure to meet minimum federal safety or emissions standards. Manufacturer recalls are repaired at no cost to the customer.

New Owner Reported

When a vehicle is sold to a new owner, the Title must be transferred to the new owner(s) at a Department of Motor Vehicles.

Ownership History

CARFAX defines an owner as an individual or business that possesses and uses a vehicle. Not all title transactions represent changes in ownership. To provide estimated number of owners, CARFAX proprietary technology analyzes all the events in a vehicle history. Estimated ownership is available for vehicles manufactured after 1991 and titled solely in the US including Puerto Rico. Dealers sometimes opt to take ownership of a vehicle and are required to in the following states: Maine, Massachusetts, New Jersey, Ohio, Oklahoma, Pennsylvania and South Dakota. Please consider this as you review a vehicle's estimated ownership history.

Title Issued

A state issues a title to provide a vehicle owner with proof of ownership. Each title has a unique number. Each title or registration record on a CARFAX report does not necessarily indicate a change in ownership. In Canada, a registration and bill of sale are used as proof of ownership.