



# Vehicle History Report™

US \$44.99

## 2003 TOYOTA 4RUNNER SR5

VIN: JTEBT14R430026017  
4 DOOR WAGON/SPORT UTILITY  
4.7L V8 F DOHC 32V  
GASOLINE  
ALL WHEEL DRIVE

Damage reported: minor damage

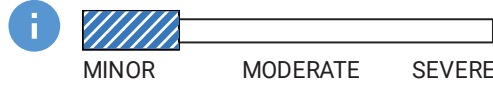

24 Service history records



4 Previous owners



Personal vehicle



98,700 Last reported odometer reading



## Ownership History

The number of owners is estimated

	Owners 1-2	Owner 3	Owner 4
Year purchased	2003	2017	2018
Type of owner	Personal	Personal	Personal
Estimated length of ownership	13 yrs. 7 mo.	10 months	5 yrs. 6 mo.
Owned in the following states/provinces	Nebraska, Minnesota	Minnesota	Minnesota
Estimated miles driven per year	See Details	---	---
Last reported odometer reading	98,578	98,700	---



## Title History

CARFAX guarantees the information in this section

	Owners 1-2	Owner 3	Owner 4
<b>Damage Brands</b> Salvage   Junk   Rebuilt   Fire   Flood   Hail   Lemon	<input checked="" type="checkbox"/> <b>Guaranteed</b> No Problem	<input checked="" type="checkbox"/> <b>Guaranteed</b> No Problem	<input checked="" type="checkbox"/> <b>Guaranteed</b> No Problem
<b>Odometer Brands</b> Not Actual Mileage   Exceeds Mechanical Limits	<input checked="" type="checkbox"/> <b>Guaranteed</b> No Problem	<input checked="" type="checkbox"/> <b>Guaranteed</b> No Problem	<input checked="" type="checkbox"/> <b>Guaranteed</b> No Problem



## Additional History

Not all accidents / issues are reported to CARFAX

	Owners 1-2	Owner 3	Owner 4
<b>Total Loss</b> No total loss reported to CARFAX.	<input checked="" type="checkbox"/> No Issues Reported	<input checked="" type="checkbox"/> No Issues Reported	<input checked="" type="checkbox"/> No Issues Reported
<b>Structural Damage</b>	<input checked="" type="checkbox"/> No Issues	<input checked="" type="checkbox"/> No Issues	<input checked="" type="checkbox"/> No Issues

CARFAX recommends that you have this vehicle inspected by a collision repair specialist.	— Reported	— Reported	— Reported
<b>Airbag Deployment</b> No airbag deployment reported to CARFAX.	✓ No Issues Reported	✓ No Issues Reported	✓ No Issues Reported
<b>Odometer Check</b> No indication of an odometer rollback.	✓ No Issues Indicated	✓ No Issues Indicated	✓ No Issues Indicated
<b>Accident / Damage</b> Damage reported: 02/28/2019.	✓ No Issues Reported	✓ No Issues Reported	Minor Damage
<b>Manufacturer Recall</b> No open recalls reported to CARFAX. Check with an authorized Toyota dealer for any open recalls. View Toyota disclosure	✓ No Recalls Reported	✓ No Recalls Reported	✓ No Recalls Reported
<b>Basic Warranty</b> Original warranty estimated to have expired.	<b>Warranty Expired</b>	<b>Warranty Expired</b>	<b>Warranty Expired</b>





## Detailed History





 **Owner 1**  
Purchased: 2003



**Low mileage!** This owner drove less than the industry average of 15,000 miles per year.

Personal Vehicle  
5,306 mi/yr

Date	Mileage	Source	Comments
06/27/2003		NICB	<b>Vehicle manufactured and shipped to original dealer</b>
07/14/2003	5	Baxter Toyota Lincoln Lincoln, NE 402-476-4000 toyotaoflincoln.com ★ 4.4 / 5.0 100 Verified Reviews ♥ 168 Customer Favorites	 <b>Vehicle serviced</b> - Pre-delivery inspection completed - VIN glass etching vin etched
07/28/2003		Dealer Inventory Nebraska	<b>Vehicle sold</b>
07/29/2003	9	Nebraska Motor Vehicle Dept. Lincoln, NE	<b>Title issued or updated</b> - First owner reported - Titled or registered as personal vehicle
12/23/2003	5,092	Service Facility	 <b>Vehicle serviced</b> - Steering/suspension lubricated - Oil and filter changed
12/23/2003		Baxter Toyota Lincoln Lincoln, NE 402-476-4000 toyotaoflincoln.com ★ 4.4 / 5.0 100 Verified Reviews ♥ 168 Customer Favorites	 <b>Vehicle serviced</b> - Oil and filter changed

06/13/2006		Baxter Toyota Lincoln Lincoln, NE 402-476-4000 toyotaoflincoln.com ★ 4.4 / 5.0 100 Verified Reviews ❤️ 168 Customer Favorites		<b>Vehicle serviced</b> - Air filter replaced - Oil and filter changed - Tires rotated - Cabin air filter replaced/cleaned
11/20/2006		Baxter Toyota Lincoln Lincoln, NE 402-476-4000 toyotaoflincoln.com ★ 4.4 / 5.0 100 Verified Reviews ❤️ 168 Customer Favorites		<b>Vehicle serviced</b> - Oil and filter changed
07/24/2008		Nebraska Motor Vehicle Dept. Lincoln, NE		<b>Registration issued or renewed</b> - Vehicle color noted as Silver
11/13/2008	28,579	Baxter Toyota Lincoln Lincoln, NE 402-476-4000 toyotaoflincoln.com ★ 4.4 / 5.0 100 Verified Reviews ❤️ 168 Customer Favorites		<b>Vehicle serviced</b> - 30,000 mile service performed - Oil and filter changed
07/21/2009		Nebraska Motor Vehicle Dept. Lincoln, NE		<b>Registration issued or renewed</b> - Vehicle color noted as Silver
01/04/2010	34,197	Baxter Toyota Lincoln Lincoln, NE 402-476-4000 toyotaoflincoln.com ★ 4.4 / 5.0 100 Verified Reviews ❤️ 168 Customer Favorites		<b>Vehicle serviced</b> - Oil and filter changed - Tires rotated - Power steering fluid flushed/changed - Serpentine belt replaced

 **Owner 2**  
Purchased: 2010



**Low mileage!** This owner drove less than the industry average of 15,000 miles per year.

Personal Vehicle  
9,358 mi/yr

Date	Mileage	Source	Comments
10/20/2010	38,380	Minnesota Motor Vehicle Dept. Rochester, MN Title #G2930Z724	<b>Vehicle purchase reported</b> - Title or registration issued - New owner reported - Vehicle color noted as Silver
11/08/2010	42,000	Rochester Ford Rochester, MN 507-288-7564 rochestermotorcars.com ★ 4.6 / 5.0	 <b>Vehicle serviced</b> - Oil and filter changed - Tires rotated - Battery replaced

276 Verified Reviews  
♥ 5,274 Customer Favorites

07/08/2011 48,386 Rochester Ford  
Rochester, MN  
507-288-7564  
rochestermotorcars.com  
★ 4.6 / 5.0  
276 Verified Reviews  
♥ 5,274 Customer Favorites

 **Vehicle serviced**  
- Maintenance inspection completed  
- Oil and filter changed  
- Tires rotated

07/22/2011 Minnesota  
Motor Vehicle Dept.  
Rochester, MN  
Title #G2930Z724

**Registration issued or renewed**  
- Vehicle color noted as Silver

12/27/2011 Minnesota  
Motor Vehicle Dept.  
Rochester, MN  
Title #G2930Z724

**Registration issued or renewed**  
- Vehicle color noted as Silver

07/19/2012 57,383 Valvoline Instant Oil Change  
Rochester, MN  
507-252-1655  
vioc.com  
★ 4.5 / 5.0  
111 Verified Reviews  
♥ 197 Customer Favorites

 **Vehicle serviced**  
- Oil and filter changed  
- Front wiper blades/refills replaced

08/15/2012 57,960 Rochester Ford  
Rochester, MN  
507-288-7564  
rochestermotorcars.com  
★ 4.6 / 5.0  
276 Verified Reviews  
♥ 5,274 Customer Favorites

 **Vehicle serviced**  
- Brakes serviced  
- Electrical system checked

10/17/2012 58,587 Rochester Ford  
Rochester, MN  
507-288-7564  
rochestermotorcars.com  
★ 4.6 / 5.0  
276 Verified Reviews  
♥ 5,274 Customer Favorites

 **Vehicle serviced**  
- Air filter replaced  
- Cabin air filter replaced/cleaned

10/18/2012 Rochester Toyota  
Rochester, MN  
507-286-1200  
rochestermotorcars.com  
★ 4.7 / 5.0  
310 Verified Reviews  
♥ 6,295 Customer Favorites

 **Vehicle serviced**  
- 60,000 mile service performed  
- Air filter replaced  
- Cabin air filter replaced/cleaned

12/29/2012 62,162 Rochester Ford  
Rochester, MN  
507-288-7564  
rochestermotorcars.com  
★ - / -

 **Vehicle serviced**  
- Maintenance inspection completed  
- Oil and filter changed

★ **4.6 / 5.0**  
276 Verified Reviews  
♥ **5,274** Customer Favorites

07/01/2013

Minnesota  
Motor Vehicle Dept.  
Rochester, MN  
Title #G2930Z724

**Registration issued or renewed**  
- Vehicle color noted as Silver

09/13/2013 67,687

Rochester Toyota  
Rochester, MN  
507-286-1200  
rochestermotorcars.com



**Vehicle serviced**  
- Maintenance inspection completed  
- Oil and filter changed

★ **4.7 / 5.0**  
310 Verified Reviews  
♥ **6,295** Customer Favorites

03/31/2014

Toyota Motor Sales, USA,  
Inc.

**Manufacturer Service Campaign issued**  
- Campaign #BST SPECIAL SERVICE  
CAMPAIGN (SSC) BST MULTIPLE MODEL  
AND MODEL YEARS SMART STOP  
TECHNOLOGY  
- Status: Remedy Available

Locate an authorized Toyota dealer near you  
to schedule an appointment

⊕ **Learn more about this campaign**

05/23/2014 74,467

Rochester Toyota  
Rochester, MN  
507-286-1200  
rochestermotorcars.com



**Vehicle serviced**  
- Recommended maintenance performed  
- 15,000 mile service performed  
- Cooling system checked  
- Oil and filter changed

★ **4.7 / 5.0**  
310 Verified Reviews  
♥ **6,295** Customer Favorites

06/11/2014

Minnesota  
Motor Vehicle Dept.  
Rochester, MN  
Title #G2930Z724

**Registration issued or renewed**  
- Vehicle color noted as Silver

08/30/2014 77,120

Lexus of Lincoln  
Lincoln, NE  
402-477-3233  
lexusoflincoln.com



**Vehicle serviced**  
- Maintenance inspection completed  
- Front brake pads replaced  
- Cabin air filter replaced/cleaned  
- Wiper(s) replaced  
- A/C relay replaced  
- Air filter replaced  
- Differential fluid flushed/changed  
- Rear brake pads replaced  
- Rear brake rotor(s) resurfaced  
- Door lock(s) replaced/repared  
- Drivability/performance checked  
- Transfer case fluid flushed/changed  
- Vehicle washed/detailed

★ **4.9 / 5.0**  
34 Verified Reviews  
♥ **39** Customer Favorites

12/29/2014 79,754

Rochester Toyota  
  
Rochester, MN  
507-286-1200



**Vehicle serviced**  
- 60,000 mile service performed  
Oil and filter changed

rochestermotorcars.com  
 ★ 4.7 / 5.0  
 310 Verified Reviews  
 ❤️ 6,295 Customer Favorites

01/10/2015 80,000

Rochester Toyota  
 Rochester, MN  
 507-286-1200  
 rochestermotorcars.com  
 ★ 4.7 / 5.0  
 310 Verified Reviews  
 ❤️ 6,295 Customer Favorites



**Vehicle serviced**  
 - Light bulb(s) replaced

07/06/2016

Minnesota  
 Motor Vehicle Dept.  
 Minneapolis, MN  
 Title #G2930Z724

**Registration issued or renewed**  
 - Registration updated when owner moved the vehicle to a new location  
 - Vehicle color noted as Silver

11/09/2016 95,603

Precision Tune Auto Care  
 Minneapolis, MN  
 612-927-7620  
 precisiontune.com  
 ★ 4.9 / 5.0  
 66 Verified Reviews  
 ❤️ 76 Customer Favorites



**Vehicle serviced**

03/14/2017 98,300

Walser Bloomington Toyota  
 Bloomington, MN  
 952-888-5581  
 walsertoyota.com  
 ★ 4.3 / 5.0  
 980 Verified Reviews  
 ❤️ 21,294 Customer Favorites

**Vehicle offered for sale**

03/24/2017 98,317

Walser Recon Center  
 Saint Paul, MN  
 651-203-7500  
 https://walser.com/  
 ★ 3.9 / 5.0  
 7 Verified Reviews



**Vehicle serviced**  
 - Electrical system checked  
 - Safety inspection performed  
 - Vehicle washed/detailed

05/06/2017 98,578

Midas  
 Saint Paul, MN  
 612-200-0510  
 midas.com  
 ★ 4.8 / 5.0  
 43 Verified Reviews  
 ❤️ 126 Customer Favorites



**Vehicle serviced**  
 - Brakes checked  
 - Antifreeze/coolant checked  
 - Cooling system checked  
 - Exhaust replaced  
 - Exhaust system checked

**Owner 3**  
 Purchased: 2017

Personal Vehicle

Date	Mileage	Source	Comments
------	---------	--------	----------

05/20/2017		Minnesota Motor Vehicle Dept.	<b>Title issued or updated</b> - New owner reported
------------	--	-------------------------------	--

Saint Paul, MN  
Title #C140E0317

- Exempt from odometer reporting  
- Vehicle color noted as Silver

07/07/2017

Minnesota  
Motor Vehicle Dept.  
Saint Paul, MN  
Title #C140E0317

**Registration issued or renewed**  
- Exempt from odometer reporting  
- Vehicle color noted as Silver

08/26/2017 98,700

Midas  
Saint Paul, MN  
612-200-0510  
midas.com  
★ 4.8 / 5.0  
43 Verified Reviews  
❤️ 126 Customer Favorites



**Vehicle serviced**  
- Maintenance inspection completed  
- Exhaust replaced  
- Tires rotated  
- Oil and filter changed  
- Brakes checked  
- Exhaust system checked  
- Brush/grille guard installed  
- Alignment performed  
- Tire condition and pressure checked

11/03/2017

Midas  
Saint Paul, MN  
612-200-0510  
midas.com  
★ 4.8 / 5.0  
43 Verified Reviews  
❤️ 126 Customer Favorites



**Vehicle serviced**

**Owner 4**  
Purchased: 2018

Personal Vehicle

Date	Mileage	Source	Comments
04/06/2018		Minnesota Motor Vehicle Dept.	<b>Vehicle purchase reported</b>
04/07/2018		Minnesota Motor Vehicle Dept. Minneapolis, MN	<b>Title or registration issued</b> - New owner reported - Vehicle color noted as Silver
05/25/2018		Minnesota Motor Vehicle Dept. Minneapolis, MN Title #00QRB5Y-1	<b>Title or registration issued</b> - Exempt from odometer reporting - Vehicle color noted as Silver

02/28/2019

Damage Report



**Damage reported: minor damage**  
- Damage to front

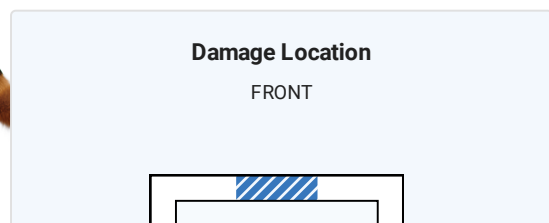
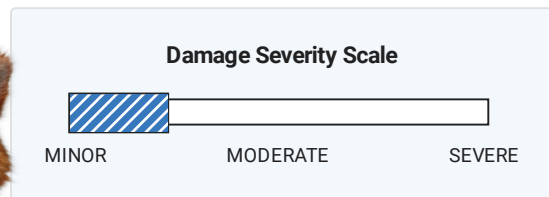



## CARFAX HAS THE MOST ACCIDENT & DAMAGE INFORMATION

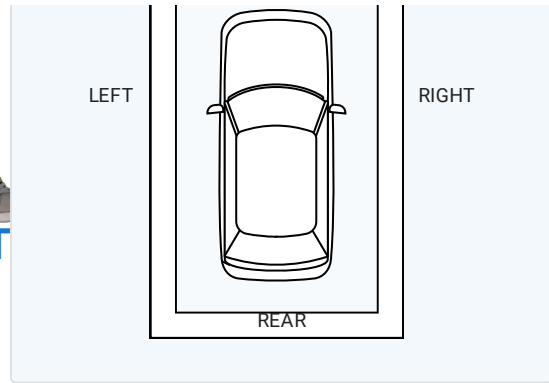

Minor damage is usually cosmetic, including dents or scratches to the vehicle body.

06/27/2019	Minnesota Motor Vehicle Dept. Minneapolis, MN Title #00QRB5Y-1	<b>Title or registration issued</b> - Exempt from odometer reporting - Vehicle color noted as Silver
06/23/2021	Minnesota Motor Vehicle Dept. Minneapolis, MN Title #00QRB5Y-1	<b>Title issued or updated</b> - Registration issued or renewed - Exempt from odometer reporting - Vehicle color noted as Silver
06/30/2022	Minnesota Motor Vehicle Dept. Minneapolis, MN Title #00QRB5Y-1	<b>Title issued or updated</b> - Registration issued or renewed - Exempt from odometer reporting - Vehicle color noted as Silver
06/26/2023	Minnesota Motor Vehicle Dept. Minneapolis, MN Title #00QRB5Y-1	<b>Title issued or updated</b> - Registration issued or renewed - Exempt from odometer reporting - Vehicle color noted as Silver
09/29/2023	Minnesota Motor Vehicle Dept. Minneapolis, MN Title #00QRB5Y-1	<b>Title issued or updated</b> - Registration issued or renewed - Exempt from odometer reporting - Vehicle color noted as Silver
10/06/2023	Online Listing	<b>Vehicle offered for sale</b>



## Glossary

### Damage Indicator

Damage can be a result of many different types of events. Examples include contact with objects (other cars, trees, traffic signs, road debris, etc), vandalism, or weather-related events. Not every damage event is reported to CARFAX. As details about the damage event become available, those additional details are added to the CARFAX Vehicle History Report. CARFAX recommends that you have this vehicle inspected by a qualified mechanic.

### Damage Severity

Damage events result in one of the following severity levels:

- **Minor:** Generally, minor damage is cosmetic (including dents or scratches), may only require reconditioning, and typically does not compromise a vehicle's operation and/or safety.
- **Moderate:** Moderate damage may affect multiple components of the vehicle and may impair the vehicle's operation and/or safety.



- **Severe:** Severe damage usually affects multiple components of the vehicle and is likely to compromise the vehicle's operation and/or safety.

CARFAX recommends getting a pre-purchase inspection at a certified collision repair facility.

#### **First Owner**

When the first owner(s) obtains a title from a Department of Motor Vehicles as proof of ownership.

#### **New Owner Reported**

When a vehicle is sold to a new owner, the Title must be transferred to the new owner(s) at a Department of Motor Vehicles.

#### **Ownership History**

CARFAX defines an owner as an individual or business that possesses and uses a vehicle. Not all title transactions represent changes in ownership. To provide estimated number of owners, CARFAX proprietary technology analyzes all the events in a vehicle history. Estimated ownership is available for vehicles manufactured after 1991 and titled solely in the US including Puerto Rico. Dealers sometimes opt to take ownership of a vehicle and are required to in the following states: Maine, Massachusetts, New Jersey, Ohio, Oklahoma, Pennsylvania and South Dakota. Please consider this as you review a vehicle's estimated ownership history.

#### **Title Issued**

A state issues a title to provide a vehicle owner with proof of ownership. Each title has a unique number. Each title or registration record on a CARFAX report does not necessarily indicate a change in ownership. In Canada, a registration and bill of sale are used as proof of ownership.

#### **Toyota Recall / Service Campaign**

Portions of this report have been included under license from Toyota Motor North America, Inc. ("TOYOTA"), License Agreement TMS1013 . This data applies only to vehicle marketed or originally sold in Mexico and the United States of America, including Guam, Saipan, American Samoa, Puerto Rico, the U.S. Virgin Islands and the other United States territories and protectorates with currently open safety or emissions recalls, or service campaigns. While TOYOTA provides data to Carfax Inc. on a regular basis, this report may not include very recent activity. For the manufacturer's most current information on recall/campaign activity for any Toyota, Lexus or Scion brand vehicle, you must go to <http://toyota.com/recall> or <http://lexus.com/recall>.