



# Vehicle History Report™

US \$44.99

## 2013 TOYOTA HIGHLANDER SE

VIN: 5TDBK3EH6DS241549  
4 DOOR WAGON/SPORT UTILITY  
3.5L V6 F DOHC 24V  
GASOLINE  
ALL WHEEL DRIVE

Damage reported: minor damage

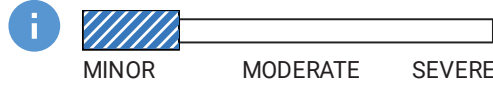

20 Service history records

CARFAX 1-Owner vehicle

Personal vehicle

124,501 Last reported odometer reading

## CARFAX Ownership History

The number of owners is estimated

Owner 1

Year purchased

2013

Type of owner

Personal

Estimated length of ownership

9 yrs. 10 mo.

Owned in the following states/provinces

Minnesota

Estimated miles driven per year

12,628/yr

Last reported odometer reading

124,501



## CARFAX Title History

CARFAX guarantees the information in this section

Owner 1

### Damage Brands

Salvage | Junk | Rebuilt | Fire | Flood | Hail | Lemon

Guaranteed  
No Problem

### Odometer Brands

Not Actual Mileage | Exceeds Mechanical Limits

Guaranteed  
No Problem

## CARFAX Additional History

Not all accidents / issues are reported to CARFAX

Owner 1

### Total Loss

No total loss reported to CARFAX.

No Issues  
Reported

### Structural Damage

CARFAX recommends that you have this vehicle inspected by a collision repair specialist.

No Issues  
Reported

<b>Airbag Deployment</b> No airbag deployment reported to CARFAX.	<input checked="" type="checkbox"/> No Issues Reported
<b>Odometer Check</b> No indication of an odometer rollback.	<input checked="" type="checkbox"/> No Issues Indicated
<b>Accident / Damage</b> Damage reported: 05/09/2016 and 05/18/2020.	Minor Damage
<b>Manufacturer Recall</b> No open recalls reported to CARFAX. Check with an authorized Toyota dealer for any open recalls. View Toyota disclosure	<input checked="" type="checkbox"/> No Recalls Reported
<b>Basic Warranty</b> Original warranty estimated to have expired.	<b>Warranty Expired</b>



## Detailed History



### Owner 1







Purchased: 2013



**Low mileage!** This owner drove less than the industry average of 15,000 miles per year.

Personal Vehicle  
12,628 mi/yr

Date	Mileage	Source	Comments
06/10/2013		NICB	<b>Vehicle manufactured and shipped to original dealer</b>
06/14/2013		Burnsville Toyota Burnsville, MN 952-435-8200 burnsvilletoyota.com ★ 4.6 / 5.0 216 Verified Reviews ♥ 239 Customer Favorites	<b>Vehicle offered for sale</b>
06/26/2013	3	Burnsville Toyota Burnsville, MN 952-435-8200 burnsvilletoyota.com ★ 4.6 / 5.0 216 Verified Reviews ♥ 239 Customer Favorites	<b>Vehicle serviced</b> - Pre-delivery inspection completed
10/28/2013		Burnsville Toyota Burnsville, MN 952-435-8200 burnsvilletoyota.com ★ 4.6 / 5.0 216 Verified Reviews ♥ 239 Customer Favorites	<b>Vehicle sold</b>
10/28/2013	20	Minnesota Motor Vehicle Dept.	<b>Vehicle purchase reported</b> - Titled or registered as personal vehicle

12/09/2013		Minnesota Motor Vehicle Dept. Hopkins, MN Title #K343A0167		<b>Title or registration issued</b> - First owner reported - Loan or lien reported - Vehicle color noted as Black
03/15/2014	4,336	Rudy Luther Toyota Scion Minneapolis, MN 763-222-2020 rudyluthertoyota.com/ ★ 4.4 / 5.0 268 Verified Reviews ❤️ 370 Customer Favorites		<b>Vehicle serviced</b> - Recommended maintenance performed - 5,000 mile service performed - Oil and filter changed
06/03/2014	7,209	Rudy Luther Toyota Scion Minneapolis, MN 763-222-2020 rudyluthertoyota.com/ ★ 4.4 / 5.0 268 Verified Reviews ❤️ 370 Customer Favorites		<b>Vehicle serviced</b>
07/31/2014	8,957	Rudy Luther Toyota Scion Minneapolis, MN 763-222-2020 rudyluthertoyota.com/ ★ 4.4 / 5.0 268 Verified Reviews ❤️ 370 Customer Favorites		<b>Vehicle serviced</b> - Maintenance inspection completed - Floor mat(s) checked
09/26/2014		Minnesota Motor Vehicle Dept. Hopkins, MN Title #K343A0167		<b>Registration issued or renewed</b> - Loan or lien reported - Registration updated when owner moved the vehicle to a new location - Vehicle color noted as Black
01/06/2015	14,404	Rudy Luther Toyota Scion Minneapolis, MN 763-222-2020 rudyluthertoyota.com/ ★ 4.4 / 5.0 268 Verified Reviews ❤️ 370 Customer Favorites		<b>Vehicle serviced</b> - Maintenance inspection completed - 15,000 mile service performed - Floor mat(s) checked
01/09/2015	14,968	Meineke Car Care Center Hopkins, MN 952-935-8320 meineke.com ★ 4.2 / 5.0 52 Verified Reviews ❤️ 306 Customer Favorites		<b>Vehicle serviced</b> - Maintenance inspection completed
01/14/2015	15,584	Midas Hopkins, MN 952-933-5551 midas.com ★ 4.8 / 5.0 72 Verified Reviews ❤️		<b>Vehicle serviced</b> - Maintenance inspection completed

 55 Customer Favorites

03/04/2015 20,582

Burnsville Toyota  
Burnsville, MN  
952-435-8200  
burnsvilletoyota.com

 4.6 / 5.0

216 Verified Reviews

 239 Customer Favorites



**Vehicle serviced**

- 20,000 mile service performed
- Battery/charging system checked
- Floor mats installed

06/20/2015 26,061

Rudy Luther Toyota Scion  
Minneapolis, MN  
763-222-2020  
rudyluthertoyota.com/

 4.4 / 5.0

268 Verified Reviews

 370 Customer Favorites



**Vehicle serviced**

09/02/2015

Minnesota  
Motor Vehicle Dept.  
Hopkins, MN  
Title #K343A0167

**Registration issued or renewed**

- Loan or lien reported
- Vehicle color noted as Black

09/18/2015 31,411

Meineke Car Care Center  
Hopkins, MN  
952-935-8320  
meineke.com

 4.2 / 5.0

52 Verified Reviews

 306 Customer Favorites



**Vehicle serviced**

- Tires rotated
- Tire(s) balanced
- Oil and filter changed
- Air filter replaced

09/26/2015 31,654

Midas  
Hopkins, MN  
952-933-5551  
midas.com

 4.8 / 5.0

72 Verified Reviews

 55 Customer Favorites



**Vehicle serviced**

- Maintenance inspection completed
- Lights checked
- Light bulb(s) replaced

11/02/2015 36,513

Meineke Car Care Center  
Hopkins, MN  
952-935-8320  
meineke.com

 4.2 / 5.0

52 Verified Reviews

 306 Customer Favorites



**Vehicle serviced**

- Cabin air filter replaced/cleaned
- Oil and filter changed

03/01/2016 42,559

Meineke Car Care Center  
Hopkins, MN  
952-935-8320  
meineke.com

 4.2 / 5.0

52 Verified Reviews

 306 Customer Favorites



**Vehicle serviced**

- Oil and filter changed
- Tires rotated

05/09/2016

Damage Report



**Damage reported: minor damage**



- Damage to left side

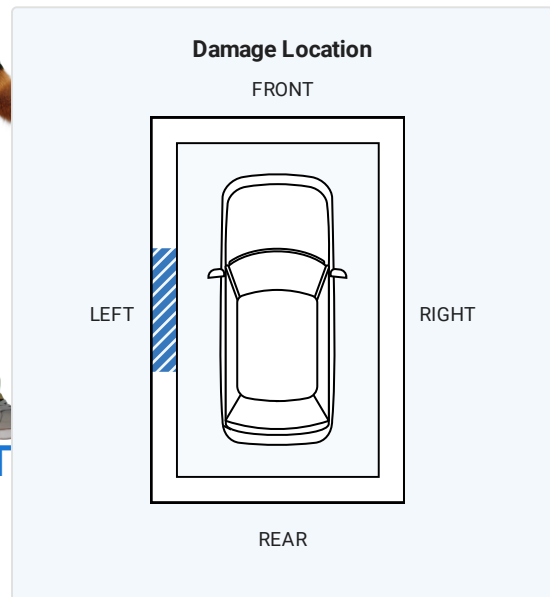
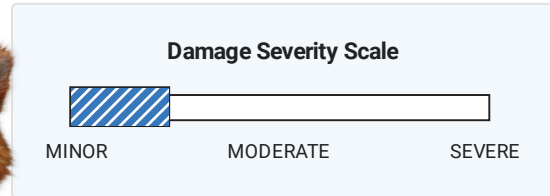

**CARFAX HAS THE MOST ACCIDENT & DAMAGE INFORMATION**



Minor damage is usually cosmetic, including dents or scratches to the vehicle body.

06/23/2016	48,199	<p>Meineke Car Care Center Hopkins, MN 952-935-8320 meineke.com</p> <p>★ <b>4.2 / 5.0</b> 52 Verified Reviews ❤️ <b>306</b> Customer Favorites</p>	 <p><b>Vehicle serviced</b> - Oil and filter changed - Tires rotated</p>
09/03/2016		<p>Minnesota Motor Vehicle Dept. Hopkins, MN Title #K343A0167</p>	<p><b>Registration issued or renewed</b> - Loan or lien reported - Registration updated when owner moved the vehicle to a new location - Vehicle color noted as Black</p>
04/08/2017	62,572	<p>Rudy Luther Toyota Scion Minneapolis, MN 763-222-2020 rudyluthertoyota.com/</p> <p>★ <b>4.4 / 5.0</b> 268 Verified Reviews ❤️ <b>370</b> Customer Favorites</p>	 <p><b>Vehicle serviced</b> - Fluids checked - Oil and filter changed</p>
08/05/2017	69,074	<p>Rudy Luther Toyota Scion Minneapolis, MN 763-222-2020 rudyluthertoyota.com/</p> <p>★ <b>4.4 / 5.0</b> 268 Verified Reviews</p>	 <p><b>Vehicle serviced</b> - Fluids checked - Oil and filter changed</p>

♥ 370 Customer Favorites

09/09/2017

Minnesota  
Motor Vehicle Dept.  
Hopkins, MN  
Title #K343A0167

**Title or registration issued**  
- Loan or lien reported  
- Vehicle color noted as Black

03/02/2018 74,719

Rudy Luther Toyota Scion  
Minneapolis, MN  
763-222-2020  
rudyluthertoyota.com/



**Vehicle serviced**  
- 75,000 mile service performed

★ 4.4 / 5.0

268 Verified Reviews

♥ 370 Customer Favorites

09/17/2018

Minnesota  
Motor Vehicle Dept.  
Hopkins, MN  
Title #K343A0167

**Title or registration issued**  
- Loan or lien reported  
- Vehicle color noted as Black

11/06/2018

Minnesota  
Motor Vehicle Dept.  
Hopkins, MN  
Title #K343A0167

**Title or registration issued**  
- Loan or lien reported  
- Vehicle color noted as Black

08/27/2019 90,247

Luther Hopkins Honda  
Hopkins, MN  
952-938-1717  
lutherhopkinshonda.com



**Vehicle serviced**  
- Recommended maintenance performed  
- Oil and filter changed  
- Tire condition and pressure checked

★ 4.6 / 5.0

265 Verified Reviews

♥ 373 Customer Favorites

11/19/2019 93,407

Rudy Luther Toyota Scion  
Minneapolis, MN  
763-222-2020  
rudyluthertoyota.com/



**Vehicle serviced**  
- Maintenance inspection completed  
- Recommended maintenance performed  
- Tire condition and pressure checked  
- Brakes checked  
- Floor mat(s) checked  
- Oil and filter changed  
- Fluids checked  
- Four tires mounted  
- Exterior light bulb(s) replaced  
- Body electrical system checked  
- Four tires replaced

★ 4.4 / 5.0

268 Verified Reviews

♥ 370 Customer Favorites

05/18/2020

Damage Report



**Damage reported: minor damage**  
- Damage to right front  
- Damage to front



**Damage Severity Scale**

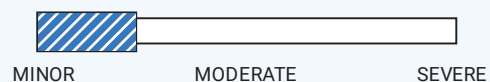

**Damage Location**

FRONT



## CARFAX HAS THE MOST ACCIDENT & DAMAGE INFORMATION

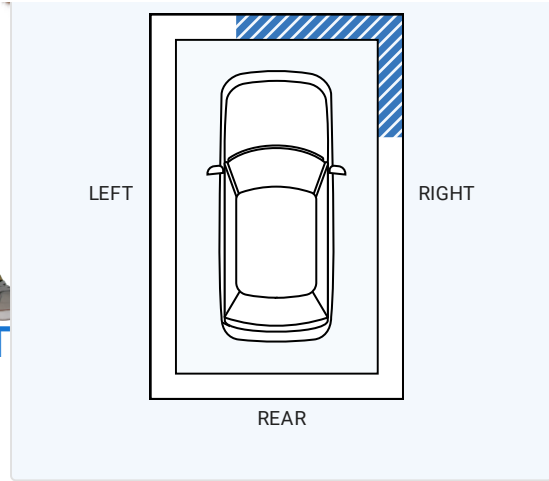

Minor damage is usually cosmetic, including dents or scratches to the vehicle body.

10/17/2020	Minnesota Motor Vehicle Dept. Hopkins, MN Title #K343A0167	<b>Title or registration issued</b> - Loan or lien reported - Vehicle color noted as Black
08/30/2021	Minnesota Motor Vehicle Dept. Hopkins, MN Title #K343A0167	<b>Title issued or updated</b> - Registration issued or renewed - Loan or lien reported - Vehicle color noted as Black
08/01/2022	Minnesota Motor Vehicle Dept. Hopkins, MN Title #K343A0167	<b>Title issued or updated</b> - Registration issued or renewed - Loan or lien reported - Vehicle color noted as Black
05/05/2023	121,173 Rudy Luther Toyota Scion Minneapolis, MN 763-222-2020 rudyluthertoyota.com/ ★ 4.4 / 5.0 268 Verified Reviews ❤️ 370 Customer Favorites	 <b>Vehicle serviced</b>
09/01/2023	Minnesota Motor Vehicle Dept. Hopkins, MN Title #K343A0167	<b>Title issued or updated</b> - Registration issued or renewed - Loan or lien reported - Vehicle color noted as Black
09/04/2023	124,501 Burnsville Toyota Burnsville, MN 952-435-8200 burnsvilletoyota.com ★ 4.6 / 5.0 216 Verified Reviews ❤️ 239 Customer Favorites	<b>Vehicle offered for sale</b>
09/06/2023	Online Listing	<b>Vehicle offered for sale</b>
09/07/2023	Minnesota Motor Vehicle Dept.	<b>Title issued or updated</b> Registration issued or renewed

Hopkins, MN  
Title #K343A0167

- Loan or lien reported  
- Vehicle color noted as Black



Avoid financial headaches. Make sure the loan has been paid off if you're buying from a private seller.  
[Learn More](#)



## Glossary

### Damage Indicator

Damage can be a result of many different types of events. Examples include contact with objects (other cars, trees, traffic signs, road debris, etc), vandalism, or weather-related events. Not every damage event is reported to CARFAX. As details about the damage event become available, those additional details are added to the CARFAX Vehicle History Report. CARFAX recommends that you have this vehicle inspected by a qualified mechanic.

### Damage Severity

Damage events result in one of the following severity levels:

- **Minor:** Generally, minor damage is cosmetic (including dents or scratches), may only require reconditioning, and typically does not compromise a vehicle's operation and/or safety.
- **Moderate:** Moderate damage may affect multiple components of the vehicle and may impair the vehicle's operation and/or safety.
- **Severe:** Severe damage usually affects multiple components of the vehicle and is likely to compromise the vehicle's operation and/or safety.

CARFAX recommends getting a pre-purchase inspection at a certified collision repair facility.

### First Owner

When the first owner(s) obtains a title from a Department of Motor Vehicles as proof of ownership.

### Ownership History

CARFAX defines an owner as an individual or business that possesses and uses a vehicle. Not all title transactions represent changes in ownership. To provide estimated number of owners, CARFAX proprietary technology analyzes all the events in a vehicle history. Estimated ownership is available for vehicles manufactured after 1991 and titled solely in the US including Puerto Rico. Dealers sometimes opt to take ownership of a vehicle and are required to in the following states: Maine, Massachusetts, New Jersey, Ohio, Oklahoma, Pennsylvania and South Dakota. Please consider this as you review a vehicle's estimated ownership history.

### Title Issued

A state issues a title to provide a vehicle owner with proof of ownership. Each title has a unique number. Each title or registration record on a CARFAX report does not necessarily indicate a change in ownership. In Canada, a registration and bill of sale are used as proof of ownership.

### Toyota Recall / Service Campaign

Portions of this report have been included under license from Toyota Motor North America, Inc. ("TOYOTA"), License Agreement TMS1013. This data applies only to vehicle marketed or originally sold in Mexico and the United States of America, including Guam, Saipan, American Samoa, Puerto Rico, the U.S. Virgin Islands and the other United States territories and protectorates with currently open safety or emissions recalls, or service campaigns. While TOYOTA provides data to Carfax Inc. on a regular basis, this report may not include very recent activity. For the manufacturer's most current information on recall/campaign activity for any Toyota, Lexus or Scion brand vehicle, you must go to <http://toyota.com/recall> or <http://lexus.com/recall>.