



Vehicle History Report™

US \$44.99

2016 FORD FOCUS ST

VIN: 1FADP3L90GL362000
HATCHBACK 4 DR
2.0L I4 F DOHC 16V
GASOLINE
FRONT WHEEL DRIVE
Original Window Sticker

Branded Titles: Rebuilt, Salvage

16 Service history records

6 Previous owners

Personal vehicle

Last owned in Minnesota

89,372 Last reported odometer reading



Ownership History

The number of owners is estimated

Owners 1-4

Owner 5

Owner 6

Year purchased

2016

2022

2023

Type of owner

Personal

Personal

Personal

Estimated length of ownership

5 yrs. 11 mo.

2 months

1 month

Owned in the following states/provinces

See Details

Minnesota

Minnesota

Estimated miles driven per year

See Details

Last reported odometer reading

84,299

89,360

89,372



Title History

CARFAX guarantees the information in this section

Owners 1-4

Owner 5

Owner 6

Damage Brands

Salvage | Junk | Rebuilt | Fire | Flood | Hail | Lemon

No Problem

Alert!
Problem Found

Alert!
Problem Found

Odometer Brands

Not Actual Mileage | Exceeds Mechanical Limits

No Problem

No Problem

No Problem



Additional History

Not all accidents / issues are reported to CARFAX

Owners 1-4

Owner 5

Owner 6

Total Loss

Total Loss Reported: 10/25/2022.

No Issues Reported

Total Loss Reported

No New Issues Reported

Structural Damage

No Issues

No Issues

No Issues

CARFAX recommends that you have this vehicle inspected by a collision repair specialist.	— Reported	— Reported	— Reported
Airbag Deployment No airbag deployment reported to CARFAX.	✓ No Issues Reported	✓ No Issues Reported	✓ No Issues Reported
Odometer Check No indication of an odometer rollback.	✓ No Issues Indicated	✓ No Issues Indicated	✓ No Issues Indicated
Accident / Damage DMV title problems reported. Damage reported: 09/08/2022.	✓ No Issues Reported	Severe Damage	Severe Damage
Manufacturer Recall A current list of recalls is available at Ford Motor Company.	✓ No Recalls Reported	✓ No Recalls Reported	✓ No Recalls Reported
Basic Warranty Original manufacturer warranty likely voided by manufacturer.	✓ Warranty Active	Warranty Voided	Warranty Voided



Detailed History





Owner 1



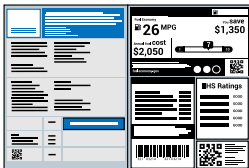

Purchased: 2016

Personal Vehicle

15,335 mi/yr

Date	Mileage	Source	Comments
06/30/2016		Ford Motor Company	Vehicle manufactured and shipped to original dealer  Original Window Sticker
07/14/2016	1	Rochester Ford Rochester, MN 507-288-7564 rochestermotorcars.com ★ 4.6 / 5.0 255 Verified Reviews ❤️ 4,965 Customer Favorites	 Vehicle serviced - Pre-delivery inspection completed
08/08/2016		Dick Brantmeier Ford Lincoln Kia Sheboygan, WI 920-458-6111 dickbrantmeier.com ★ 4.7 / 5.0 63 Verified Reviews	Vehicle offered for sale
08/09/2016	327	Dick Brantmeier Ford Lincoln Mercury Kia Sheboygan, WI 920-458-6111 dickbrantmeier.com ★ 4.7 / 5.0	Vehicle sold

63 Verified Reviews

08/15/2016		Wisconsin Motor Vehicle Dept. Sheboygan, WI Title #16228TG630044		Title issued or updated <ul style="list-style-type: none">- Registration issued or renewed- First owner reported- Titled or registered as personal vehicle- Loan or lien reported- Vehicle color noted as Blue
09/14/2016	3,349	Dick Brantmeier Ford Lincoln Kia Sheboygan, WI 920-458-6111 dickbrantmeier.com ★ 4.7 / 5.0 63 Verified Reviews		Vehicle serviced <ul style="list-style-type: none">- Maintenance inspection completed- Oil and filter changed
11/09/2016	7,773	Dick Brantmeier Ford Lincoln Kia Sheboygan, WI 920-458-6111 dickbrantmeier.com ★ 4.7 / 5.0 63 Verified Reviews		Vehicle serviced <ul style="list-style-type: none">- Maintenance inspection completed- Oil and filter changed- Tires rotated- PCM reprogrammed
01/12/2017	13,620	Dick Brantmeier Ford Lincoln Kia Sheboygan, WI 920-458-6111 dickbrantmeier.com ★ 4.7 / 5.0 63 Verified Reviews		Vehicle serviced <ul style="list-style-type: none">- Maintenance inspection completed- Oil and filter changed
01/28/2017		Wisconsin Motor Vehicle Dept. Sheboygan, WI		Registration issued or renewed <ul style="list-style-type: none">- Vehicle color noted as Blue
03/31/2017	21,531	Dick Brantmeier Ford Lincoln Kia Sheboygan, WI 920-458-6111 dickbrantmeier.com ★ 4.7 / 5.0 63 Verified Reviews		Vehicle serviced <ul style="list-style-type: none">- Maintenance inspection completed- Oil and filter changed- Tires rotated
09/29/2017	29,529	Gordie Boucher Ford Menomonee Falls, WI 262-255-9010 boucherford.com/ ★ 4.6 / 5.0 89 Verified Reviews ❤️ 74 Customer Favorites		Vehicle serviced <ul style="list-style-type: none">- Maintenance inspection completed- Battery/charging system checked- Brakes checked- Oil and filter changed- Tires rotated- Tire condition and pressure checked
01/16/2018		Wisconsin Motor Vehicle Dept. Milwaukee, WI		Registration issued or renewed <ul style="list-style-type: none">- Registration updated when owner moved the vehicle to a new location- Vehicle color noted as Blue
04/11/2018	37,642	Gordie Boucher Ford		Vehicle serviced

Menomonee Falls, WI
262-255-9010
boucherford.com/

★ 4.6 / 5.0

89 Verified Reviews

♥ 74 Customer Favorites



- Maintenance inspection completed
- Battery/charging system checked
- Brakes checked
- Air filter replaced
- Tire condition and pressure checked
- Oil and filter changed
- Tires rotated

11/09/2018 46,796

Gordie Boucher Ford
Menomonee Falls, WI
262-255-9010
boucherford.com/

★ 4.6 / 5.0

89 Verified Reviews

♥ 74 Customer Favorites



Vehicle serviced

- Maintenance inspection completed
- Battery/charging system checked
- Spark plug(s) replaced
- Tire condition and pressure checked

12/06/2019

Service Facility



Inspection performed

- Alignment checked
- Tire checked

12/06/2019 48,000

Wisconsin
Inspection Station

Passed emissions inspection

12/06/2019

Wisconsin
Motor Vehicle Dept.
Milwaukee, WI

Registration issued or renewed

- Vehicle color noted as Blue

01/06/2020 51,546

Gordie Boucher Ford
Menomonee Falls, WI
262-255-9010
boucherford.com/

★ 4.6 / 5.0

89 Verified Reviews

♥ 74 Customer Favorites



Vehicle serviced

- Maintenance inspection completed
- Four wheel alignment performed
- Battery/charging system checked
- Brakes checked
- Oil and filter changed
- Tires rotated
- Tire condition and pressure checked

02/03/2020

Wisconsin
Motor Vehicle Dept.
Milwaukee, WI

Registration issued or renewed

- Vehicle color noted as Blue

05/20/2020 57,982

Gordie Boucher Ford
Menomonee Falls, WI
262-255-9010
boucherford.com/

★ 4.6 / 5.0

89 Verified Reviews

♥ 74 Customer Favorites



Vehicle serviced

- Oil and filter changed
- Front wiper blades/refills replaced

05/26/2020

Ford Blue Advantage
Certified Dealer
Menomonee Falls, WI





Sold as a Ford Blue Advantage certified used vehicle

 Visit the website of -
FORD Certified
Pre-Owned
Program



Owner 2
Purchased: 2020

Personal Vehicle
17,659 mi/yr

Date	Mileage	Source	Comments
05/26/2020	58,027	Wisconsin Motor Vehicle Dept. Rochester, MN	Odometer reading reported
06/04/2020		Minnesota Motor Vehicle Dept.	Vehicle purchase reported
06/04/2020		Wisconsin Motor Vehicle Dept. Rochester, MN Title #20156C4800013	Title issued or updated - New owner reported - Loan or lien reported - Vehicle color noted as Blue
06/23/2020		Minnesota Motor Vehicle Dept. Rochester, MN	Title or registration issued - Loan or lien reported - Vehicle color noted as Blue
05/21/2021		Minnesota Motor Vehicle Dept. Rochester, MN	Registration issued or renewed - Vehicle color noted as Blue
06/04/2021	70,269	Valvoline Instant Oil Change Rochester, MN 507-252-1655 vioc.com ★ 4.5 / 5.0 108 Verified Reviews ❤️ 198 Customer Favorites	 Vehicle serviced - Oil and filter changed
08/08/2021	73,423	Valvoline Instant Oil Change Rochester, MN 507-252-1655 vioc.com ★ 4.5 / 5.0 108 Verified Reviews ❤️ 198 Customer Favorites	 Vehicle serviced - Fuel injection system checked - Oil and filter changed
09/09/2021	77,814	Valvoline Instant Oil Change Rochester, MN 507-252-1655 vioc.com ★ 4.5 / 5.0 108 Verified Reviews ❤️ 198 Customer Favorites	 Vehicle serviced - Oil and filter changed
10/23/2021	82,197	Valvoline Instant Oil Change Rochester, MN 507-252-1655 vioc.com ★ 4.5 / 5.0 108 Verified Reviews ❤️ 198 Customer Favorites	 Vehicle serviced - Oil and filter changed
11/20/2021	84,299	Valvoline Instant Oil Change Rochester, MN 507-252-1655 vioc.com	 Vehicle serviced - Oil and filter changed

★ 4.5 / 5.0
 108 Verified Reviews
 ❤️ 198 Customer Favorites

 **Owner 3**
 Purchased: 2022

Personal Vehicle

Date	Mileage	Source	Comments
04/30/2022		Minnesota Motor Vehicle Dept. Rochester, MN	Registration issued or renewed - New owner reported - Vehicle color noted as Blue

 **Owner 4**
 Purchased: 2022

Personal Vehicle

Date	Mileage	Source	Comments
07/06/2022		Minnesota Motor Vehicle Dept. Rochester, MN Title #19658244-1	Title issued or updated - Registration issued or renewed - New owner reported - Loan or lien reported - Vehicle color noted as Blue

 **Owner 5**
 Purchased: 2022

Personal Vehicle

Date	Mileage	Source	Comments
07/29/2022	87,200	Minnesota Motor Vehicle Dept.	Vehicle purchase reported
08/09/2022		Minnesota Motor Vehicle Dept. Rochester, MN Title #19658244-1	Title issued or updated - Registration issued or renewed - New owner reported - Vehicle color noted as Blue
08/31/2022		Minnesota Motor Vehicle Dept. Meadowlands, MN Title #19813768-1	Title issued or updated - Loan or lien reported - Vehicle color noted as Blue

09/08/2022 Damage Report

 **Damage reported: minor damage**
 - Damage to front

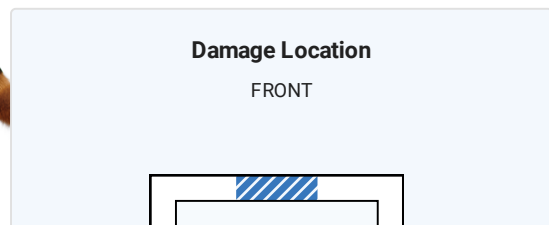
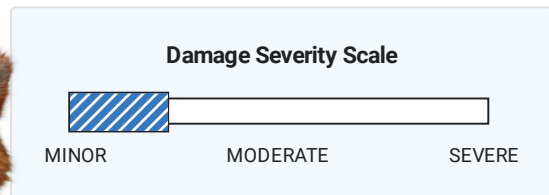



CARFAX HAS THE MOST ACCIDENT & DAMAGE INFORMATION

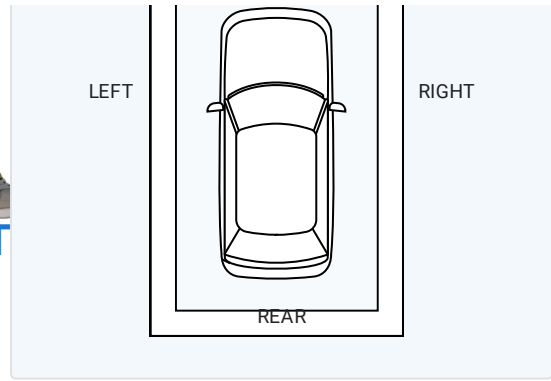

10/20/2022 89,360 Minnesota Motor Vehicle Dept. **Vehicle purchase reported**

10/25/2022 Damage Report



TOTAL LOSS VEHICLE



There are many reasons an insurance company will declare a vehicle a total loss. Have this vehicle inspected by a qualified technician before you buy. [Learn More](#)

10/25/2022 Minnesota Motor Vehicle Dept. Avon, MN **Title or registration issued to insurance company**
- Vehicle color noted as Blue

12/02/2022 Minnesota Motor Vehicle Dept. Avon, MN Title #20180489-1 **SALVAGE TITLE/CERTIFICATE ISSUED**
- Vehicle color noted as Blue

01/26/2023 Minnesota Motor Vehicle Dept. Avon, MN Title #20180489-1 **SALVAGE TITLE/CERTIFICATE ISSUED**
- Vehicle color noted as Blue

Owner 6 Purchased: 2023 Personal Vehicle

Date	Mileage	Source	Comments
08/05/2023	89,372	Minnesota Motor Vehicle Dept.	Vehicle purchase reported
08/10/2023		Minnesota Motor Vehicle Dept. Farmington, MN	Title issued or updated - Registration issued or renewed - New owner reported - Vehicle color noted as Blue
08/24/2023		Minnesota Motor Vehicle Dept. Farmington, MN Title #21407668-1	SALVAGE TITLE/CERTIFICATE ISSUED - REBUILT TITLE ISSUED - Vehicle color noted as Blue



Glossary

Damage Indicator

Damage can be a result of many different types of events. Examples include contact with objects (other cars, trees, traffic signs, road debris, etc), vandalism, or weather-related events. Not every damage event is reported to CARFAX. As details about the damage event become available, those additional details are added to the CARFAX Vehicle History Report. CARFAX recommends that you have this vehicle inspected by a qualified mechanic.

Damage Severity

Damage events result in one of the following severity levels:

- **Minor:** Generally, minor damage is cosmetic (including dents or scratches), may only require reconditioning, and typically does not compromise a vehicle's operation and/or safety.
- **Moderate:** Moderate damage may affect multiple components of the vehicle and may impair the vehicle's operation and/or safety.
- **Severe:** Severe damage usually affects multiple components of the vehicle and is likely to compromise the vehicle's operation and/or safety.

CARFAX recommends getting a pre-purchase inspection at a certified collision repair facility.

First Owner

When the first owner(s) obtains a title from a Department of Motor Vehicles as proof of ownership.

Ford or Lincoln Mercury Recall

The Ford Motor Company provides CARFAX with Field Service Action and recall information regarding safety, compliance and emissions programs announced since 2000 for a specific vehicle. For complete information regarding programs or concerns about this vehicle, please contact a local Ford or Lincoln Mercury Dealer.

New Owner Reported

When a vehicle is sold to a new owner, the Title must be transferred to the new owner(s) at a Department of Motor Vehicles.

Ownership History

CARFAX defines an owner as an individual or business that possesses and uses a vehicle. Not all title transactions represent changes in ownership. To provide estimated number of owners, CARFAX proprietary technology analyzes all the events in a vehicle history. Estimated ownership is available for vehicles manufactured after 1991 and titled solely in the US including Puerto Rico. Dealers sometimes opt to take ownership of a vehicle and are required to in the following states: Maine, Massachusetts, New Jersey, Ohio, Oklahoma, Pennsylvania and South Dakota. Please consider this as you review a vehicle's estimated ownership history.

Rebuilt/Reconstructed Title

A Rebuilt/Reconstructed vehicle is a salvage vehicle that has been repaired and restored to operation. These vehicles are often severely damaged before they are rebuilt and refurbished parts are typically used during reconstruction. In most states, an inspection of the vehicle is required before the vehicle is allowed to return to the road.

Salvage Title

A Salvage Title is issued on a vehicle damaged to the extent that the cost of repairing the vehicle exceeds approximately 75% of its pre-damage value. This damage threshold may vary by state. Some states treat Junk titles the same as Salvage but the majority use this title to indicate that a vehicle is not road worthy and cannot be titled again in that state. The following eleven states also use Salvage titles to identify stolen vehicles - AZ, FL, GA, IL, MD, MN, NJ, NM, NY, OK and OR.

Title Issued

A state issues a title to provide a vehicle owner with proof of ownership. Each title has a unique number. Each title or registration record on a CARFAX report does not necessarily indicate a change in ownership. In Canada, a registration and bill of sale are used as proof of ownership.

Total Loss Vehicle

An insurance or fleet company declares a vehicle a total loss when a claim exceeds approximately 75% of its pre-damage value or if the vehicle is stolen and not recovered. This damage threshold varies by company. These companies typically take possession and obtain the title. Not all total loss vehicles result in a DMV-reported branded title. This may occur when an insurance company's definition of a total loss is different than the state DMV's definition for a branded title or when the owner of the vehicle is a self-insured company, like a fleet or rental company.