



# Vehicle History Report™

US \$44.99

## 2005 TOYOTA SIENNA XLE LIMITED 7 PASSENGER

VIN: 5TDBA22C05S037479  
VAN  
3.3L V6 F DOHC 24V  
GASOLINE  
ALL WHEEL DRIVE

### Accident reported: minor damage

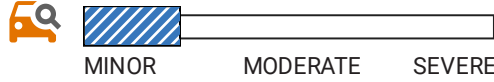

**63** Service history records

**2** Previous owners

Personal vehicle

**199,524** Last reported odometer reading

## Ownership History

The number of owners is estimated

	Owner 1	Owner 2
Year purchased	2005	2020
Type of owner	Personal	Personal
Estimated length of ownership	15 yrs. 5 mo.	2 yrs. 10 mo.
Owned in the following states/provinces	Nebraska	Nebraska, Iowa
Estimated miles driven per year	10,556/yr	18,387/yr
Last reported odometer reading	162,000	199,524

## Title History

CARFAX guarantees the information in this section

	Owner 1	Owner 2
<b>Damage Brands</b> Salvage   Junk   Rebuilt   Fire   Flood   Hail   Lemon	<b>Guaranteed</b> No Problem	<b>Guaranteed</b> No Problem
<b>Odometer Brands</b> Not Actual Mileage   Exceeds Mechanical Limits	<b>Guaranteed</b> No Problem	<b>Guaranteed</b> No Problem

## Additional History

Not all accidents / issues are reported to CARFAX

	Owner 1	Owner 2
<b>Total Loss</b> No total loss reported to CARFAX.	No Issues Reported	No Issues Reported
<b>Structural Damage</b> CARFAX recommends that you have this vehicle inspected by a collision	No Issues Reported	No Issues Reported

repair specialist.		
<b>Airbag Deployment</b> No airbag deployment reported to CARFAX.	<input checked="" type="checkbox"/> No Issues Reported	<input checked="" type="checkbox"/> No Issues Reported
<b>Odometer Check</b> No indication of an odometer rollback.	<input checked="" type="checkbox"/> No Issues Indicated	<input checked="" type="checkbox"/> No Issues Indicated
<b>Accident / Damage</b> Accidents reported: 04/05/2016 and 12/09/2019.	Minor Damage	No New Issues Reported
<b>Manufacturer Recall</b> No open recalls reported to CARFAX. Check with an authorized Toyota dealer for any open recalls. View Toyota disclosure	<input checked="" type="checkbox"/> No Recalls Reported	<input checked="" type="checkbox"/> No Recalls Reported
<b>Basic Warranty</b> Original warranty estimated to have expired.	<b>Warranty Expired</b>	<b>Warranty Expired</b>



## Detailed History



### Owner 1

Purchased: 2005



**Low mileage!** This owner drove less than the industry average of 15,000 miles per year.

Personal Vehicle  
10,556 mi/yr

Date	Mileage	Source	Comments
01/10/2005		NICB	<b>Vehicle manufactured and shipped to original dealer</b>
02/01/2005		Village Pointe Toyota Elkhorn, NE 402-496-4444 villagepointetoyota.com ★ 4.2 / 5.0 438 Verified Reviews ❤️ 6,299 Customer Favorites	<b>Vehicle serviced</b> - Pre-delivery inspection completed
04/07/2005	40	Nebraska Motor Vehicle Dept.	<b>Vehicle purchase reported</b> - Titled or registered as personal vehicle
04/08/2005		Nebraska Motor Vehicle Dept. Omaha, NE	<b>Title issued or updated</b> - First owner reported - Vehicle color noted as White
05/25/2005		Village Pointe Toyota Elkhorn, NE 402-496-4444 villagepointetoyota.com ★ 4.2 / 5.0 438 Verified Reviews ❤️ 6,299 Customer Favorites	<b>Vehicle serviced</b> - Oil and filter changed
06/23/2005		Village Pointe Toyota Elkhorn, NE 402-496-4444 villagepointetoyota.com	<b>Vehicle serviced</b> - Oil and filter changed

★ 4.2 / 5.0  
438 Verified Reviews  
❤️ 6,299 Customer Favorites

09/08/2005

Village Pointe Toyota  
Elkhorn, NE  
402-496-4444  
villagepointetoyota.com



**Vehicle serviced**

★ 4.2 / 5.0  
438 Verified Reviews  
❤️ 6,299 Customer Favorites

03/24/2006

Village Pointe Toyota  
Elkhorn, NE  
402-496-4444  
villagepointetoyota.com



**Vehicle serviced**

- Interior trim repaired
- Brakes checked
- Oil and filter changed
- Tires rotated

★ 4.2 / 5.0  
438 Verified Reviews  
❤️ 6,299 Customer Favorites

10/02/2006

Village Pointe Toyota  
Elkhorn, NE  
402-496-4444  
villagepointetoyota.com



**Vehicle serviced**

- Oil and filter changed

★ 4.2 / 5.0  
438 Verified Reviews  
❤️ 6,299 Customer Favorites

05/22/2007

Village Pointe Toyota  
Elkhorn, NE  
402-496-4444  
villagepointetoyota.com



**Vehicle serviced**

- Brakes checked
- Oil and filter changed
- Tires rotated

★ 4.2 / 5.0  
438 Verified Reviews  
❤️ 6,299 Customer Favorites

02/01/2008

Village Pointe Toyota  
Elkhorn, NE  
402-496-4444  
villagepointetoyota.com



**Vehicle serviced**

★ 4.2 / 5.0  
438 Verified Reviews  
❤️ 6,299 Customer Favorites

04/18/2008

Village Pointe Toyota  
Elkhorn, NE  
402-496-4444  
villagepointetoyota.com



**Vehicle serviced**

- Brakes checked
- Oil and filter changed
- Tires rotated
- Four wheel alignment performed

★ 4.2 / 5.0  
438 Verified Reviews  
❤️ 6,299 Customer Favorites

10/20/2008

Village Pointe Toyota  
Elkhorn, NE  
402-496-4444  
villagepointetoyota.com



**Vehicle serviced**

- Cabin air filter replaced/cleaned
- Air filter replaced
- Oil and filter changed

★ 4.2 / 5.0

★ 4.2 / 5.0  
438 Verified Reviews  
♥ 6,299 Customer Favorites

05/26/2009

Village Pointe Toyota  
Elkhorn, NE  
402-496-4444  
villagepointetoyota.com



**Vehicle serviced**  
- Oil and filter changed

★ 4.2 / 5.0  
438 Verified Reviews  
♥ 6,299 Customer Favorites

05/27/2009

Nebraska  
Motor Vehicle Dept.  
Omaha, NE

**Registration issued or renewed**  
- Vehicle color noted as White

09/01/2009

Village Pointe Toyota  
Elkhorn, NE  
402-496-4444  
villagepointetoyota.com



**Vehicle serviced**  
- 30,000 mile service performed  
- Transmission fluid flushed  
- Front brake rotor(s) resurfaced  
- Front brake pads replaced

★ 4.2 / 5.0  
438 Verified Reviews  
♥ 6,299 Customer Favorites

03/11/2010

Village Pointe Toyota  
Elkhorn, NE  
402-496-4444  
villagepointetoyota.com



**Vehicle serviced**  
- Oil and filter changed

★ 4.2 / 5.0  
438 Verified Reviews  
♥ 6,299 Customer Favorites

05/03/2010

Nebraska  
Motor Vehicle Dept.  
Omaha, NE

**Registration issued or renewed**  
- Vehicle color noted as White

06/21/2010 42,130

Baxter Toyota La Vista  
La Vista, NE  
402-731-2000  
toyotaoflavista.com



**Vehicle serviced**  
- Fluids checked  
- Oil and filter changed  
- Drive belt(s) replaced  
- Battery serviced  
- Cabin air filter replaced/cleaned  
- Induction system serviced  
- Door check replaced

★ 4.5 / 5.0  
185 Verified Reviews  
♥ 153 Customer Favorites

12/14/2010

Village Pointe Toyota  
Elkhorn, NE  
402-496-4444  
villagepointetoyota.com



**Vehicle serviced**  
- Oil and filter changed  
- Four wheel alignment performed  
- Tire condition and pressure checked

★ 4.2 / 5.0  
438 Verified Reviews  
♥ 6,299 Customer Favorites

05/04/2011

Village Pointe Toyota  
Elkhorn, NE  
402-496-4444  
villagepointetoyota.com



**Vehicle serviced**  
- Oil and filter changed

★ 4.2 / 5.0  
438 Verified Reviews

438 Verified Reviews  
 **6,299** Customer Favorites

05/04/2011

Nebraska  
Motor Vehicle Dept.  
Omaha, NE

**Registration issued or renewed**  
- Vehicle color noted as White

07/20/2011

Village Pointe Toyota  
Elkhorn, NE  
402-496-4444  
villagepointetoyota.com



**Vehicle serviced**  
- Oil and filter changed

★ **4.2 / 5.0**

438 Verified Reviews  
 **6,299** Customer Favorites

08/17/2011

Village Pointe Toyota  
Elkhorn, NE  
402-496-4444  
villagepointetoyota.com



**Vehicle serviced**  
- Brake light bulb(s) replaced  
- Four wheel alignment performed  
- Oil and filter changed  
- Cabin air filter replaced/cleaned  
- Air filter replaced

★ **4.2 / 5.0**

438 Verified Reviews  
 **6,299** Customer Favorites

11/23/2011

Village Pointe Toyota  
Elkhorn, NE  
402-496-4444  
villagepointetoyota.com



**Vehicle serviced**  
- Oil and filter changed  
- Brake light bulb(s) replaced

★ **4.2 / 5.0**

438 Verified Reviews  
 **6,299** Customer Favorites

02/08/2012 63,231

Baxter Toyota La Vista  
La Vista, NE  
402-731-2000  
toyotaoflavista.com



**Vehicle serviced**  
- 5,000 mile service performed  
- Oil and filter changed  
- Tires rotated  
- Pulley replaced

★ **4.5 / 5.0**

185 Verified Reviews  
 **153** Customer Favorites

02/27/2012 63,497

2 Men and a Shop  
Bennington, NE  
402-238-3330  
2menandashop.com



**Vehicle serviced**  
- Maintenance inspection completed  
- Air filter replaced  
- Brake pads replaced  
- Brake rotor(s) resurfaced  
- Wiper(s) replaced  
- Drivability/performance checked  
- Rear brake pads replaced  
- Brake fluid checked

★ **5.0 / 5.0**

29 Verified Reviews  
 **19** Customer Favorites

04/25/2012

Nebraska  
Motor Vehicle Dept.  
Omaha, NE

**Registration issued or renewed**  
- Vehicle color noted as White

02/26/2013 68,936

2 Men and a Shop  
Bennington, NE  
402-238-3330  
2menandashop.com



**Vehicle serviced**  
- Maintenance inspection completed  
- Oil and filter changed  
- Drivability/performance checked  
- Front brake pads replaced

★ **5.0 / 5.0**

29 Verified Reviews

29 verified reviews

 19 Customer Favorites

- Brake fluid checked
- Brake pads replaced
- Air filter checked
- Fluids checked
- Tire condition and pressure checked
- Body lubricated
- Brake rotor(s) resurfaced

05/20/2013

Nebraska  
Motor Vehicle Dept.  
Omaha, NE

**Registration issued or renewed**

- Vehicle color noted as White

09/20/2013

73,771

2 Men and a Shop  
Bennington, NE  
402-238-3330  
2menandashop.com

 5.0 / 5.0

29 Verified Reviews

 19 Customer Favorites



**Vehicle serviced**

- Maintenance inspection completed
- Oil and filter changed
- Brakes checked
- Drivability/performance checked
- Air filter checked
- Fluids checked
- Tire condition and pressure checked
- Body lubricated

04/09/2014

79,039

Village Pointe Toyota  
Elkhorn, NE  
402-496-4444  
villagepointetoyota.com

 4.2 / 5.0

438 Verified Reviews

 6,299 Customer Favorites



**Vehicle serviced**

- Maintenance inspection completed
- Drivability/performance checked
- Oil and filter changed
- Tires rotated
- Vehicle washed/detailed

04/30/2014

Nebraska  
Motor Vehicle Dept.  
Omaha, NE

**Registration issued or renewed**

- Vehicle color noted as White

05/17/2014

80,303

Village Pointe Toyota  
Elkhorn, NE  
402-496-4444  
villagepointetoyota.com

 4.2 / 5.0

438 Verified Reviews

 6,299 Customer Favorites



**Vehicle serviced**

- Maintenance inspection completed
- Vehicle washed/detailed

08/01/2014

81,150

2 Men and a Shop  
Bennington, NE  
402-238-3330  
2menandashop.com

 5.0 / 5.0

29 Verified Reviews

 19 Customer Favorites



**Vehicle serviced**

- Cooling system checked
- Antifreeze/coolant flushed/changed

01/24/2015

86,685

Baxter Toyota La Vista  
La Vista, NE  
402-731-2000  
toyotaoflavista.com

 4.5 / 5.0

185 Verified Reviews

 153 Customer Favorites



**Vehicle serviced**

- Maintenance inspection completed
- Oil and filter changed

04/22/2015

Nebraska

**Registration issued or renewed**

Motor Vehicle Dept.  
Omaha, NE

- Vehicle color noted as White

06/25/2015 92,119

Baxter Toyota La Vista  
La Vista, NE  
402-731-2000  
toyotaoflavista.com

★ 4.5 / 5.0

185 Verified Reviews

♥ 153 Customer Favorites



**Vehicle serviced**

- Maintenance inspection completed
- 5,000 mile service performed
- Oil and filter changed
- Tires rotated

11/18/2015 97,753

2 Men and a Shop  
Bennington, NE  
402-238-3330  
2menandashop.com

★ 5.0 / 5.0

29 Verified Reviews

♥ 19 Customer Favorites



**Vehicle serviced**

- Maintenance inspection completed
- Oil and filter changed
- Light bulb(s) replaced
- Cabin air filter replaced/cleaned
- Drivability/performance checked
- Air filter checked
- Fluids checked
- Tire condition and pressure checked
- Body lubricated
- Headlight bulb(s) replaced

03/08/2016 101,332

Village Pointe Toyota  
Elkhorn, NE  
402-496-4444  
villagepointetoyota.com

★ 4.2 / 5.0

438 Verified Reviews

♥ 6,299 Customer Favorites



**Vehicle serviced**

- Vehicle washed/detailed

04/05/2016

Damage Report



**Accident reported: minor damage**

- Vehicle involved in a rear-end collision with another motor vehicle
- Damage to rear
- Rear center primarily damaged
- Vehicle functional
- Airbags did not deploy



**Damage Severity Scale**

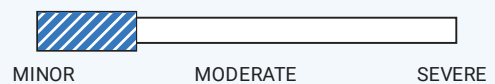

**Damage Location**

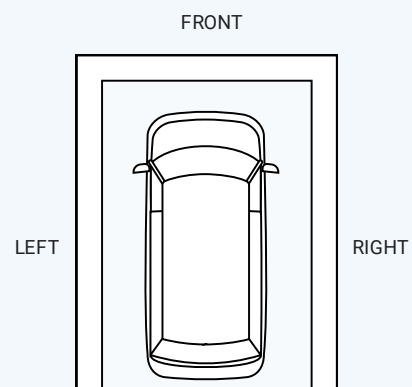

CAR FOX HAS THE MOST

**CARFAX HAS THE MOST  
ACCIDENT & DAMAGE  
INFORMATION**



REAR









Minor damage is usually cosmetic, including dents or scratches to the vehicle body.

05/13/2016		Nebraska Motor Vehicle Dept. Omaha, NE		<b>Registration issued or renewed</b> - Vehicle color noted as White
05/27/2016	103,681	Huber Chevrolet-Cadillac Omaha, NE 402-496-0220 hubercars.com ★ 4.5 / 5.0 139 Verified Reviews		<b>Vehicle serviced</b>
05/31/2016	104,576	Village Pointe Toyota Elkhorn, NE 402-496-4444 villagepointetoyota.com ★ 4.2 / 5.0 438 Verified Reviews ❤️ 6,299 Customer Favorites		<b>Vehicle serviced</b> - Maintenance inspection completed - Steering/suspension checked - Front suspension serviced - Oil and filter changed - Four wheel alignment performed - Power steering fluid flushed/changed - Light bulb(s) replaced - Vehicle washed/detailed
11/22/2016	111,213	Village Pointe Toyota Elkhorn, NE 402-496-4444 villagepointetoyota.com ★ 4.2 / 5.0 438 Verified Reviews ❤️ 6,299 Customer Favorites		<b>Vehicle serviced</b> - Maintenance inspection completed - Brakes checked - Oil and filter changed
11/29/2016	111,462	2 Men and a Shop Bennington, NE 402-238-3330 2menandashop.com ★ 5.0 / 5.0 29 Verified Reviews ❤️ 19 Customer Favorites		<b>Vehicle serviced</b> - Drivability/performance checked - Front brake pads replaced - Brake fluid checked - Light bulb(s) replaced - Brake pads replaced - Brake rotor(s) resurfaced - Brakes checked
02/08/2017	114,407	Walmart Auto Care Center Omaha, NE 402-289-9280 https://www.walmart.com ★ 4.9 / 5.0 10 Verified Reviews		<b>Vehicle serviced</b> - Tire(s) balanced - Tire(s) replaced
04/26/2017		Walmart Auto Care Center Omaha, NE 402-289-9280 https://www.walmart.com ★ 4.9 / 5.0		<b>Vehicle serviced</b> - Tire(s) balanced - Tire(s) replaced



 10 Verified Reviews

06/06/2017	118,271	2 Men and a Shop Bennington, NE 402-238-3330 2menandashop.com ★ <b>5.0 / 5.0</b> 29 Verified Reviews ❤️ <b>19</b> Customer Favorites	 <b>Vehicle serviced</b> - Maintenance inspection completed - Brakes checked - Oil and filter changed - Transmission fluid flushed - Transmission fluid changed - Brake pads replaced - Drivability/performance checked - Air filter checked - Fluids checked - Tire condition and pressure checked - Body lubricated
06/14/2017		Nebraska Motor Vehicle Dept. Omaha, NE	<b>Registration issued or renewed</b> - Registration updated when owner moved the vehicle to a new location - Vehicle color noted as White
08/31/2017	121,676	Village Pointe Toyota Elkhorn, NE 402-496-4444 villagepointetoyota.com ★ <b>4.2 / 5.0</b> 438 Verified Reviews ❤️ <b>6,299</b> Customer Favorites	 <b>Vehicle serviced</b> - Four wheel alignment performed - Cabin air filter replaced/cleaned
10/13/2017	123,826	Village Pointe Toyota Elkhorn, NE 402-496-4444 villagepointetoyota.com ★ <b>4.2 / 5.0</b> 438 Verified Reviews ❤️ <b>6,299</b> Customer Favorites	 <b>Vehicle serviced</b> - Oil and filter changed
10/27/2017	124,234	2 Men and a Shop Bennington, NE 402-238-3330 2menandashop.com ★ <b>5.0 / 5.0</b> 29 Verified Reviews ❤️ <b>19</b> Customer Favorites	 <b>Vehicle serviced</b> - Timing belt replaced - Transmission fluid flushed - Transmission fluid changed - Timing belt tensioner/idler checked - Engine/powertrain computer/module checked - Wiper(s) replaced
12/29/2017	126,876	2 Men and a Shop Bennington, NE 402-238-3330 2menandashop.com ★ <b>5.0 / 5.0</b> 29 Verified Reviews ❤️ <b>19</b> Customer Favorites	 <b>Vehicle serviced</b> - Transmission fluid changed - Oil and filter changed
03/13/2018	130,642	Village Pointe Toyota Elkhorn, NE 402-496-4444 villagepointetoyota.com ★ <b>4.2 / 5.0</b> 438 Verified Reviews	 <b>Vehicle serviced</b> - Maintenance inspection completed - 5,000 mile service performed - Oil and filter changed - Tires rotated - Brakes checked - Front brake pads replaced

 **6,299** Customer Favorites

- Front brake pads replaced  
- Cabin air filter replaced/cleaned

04/24/2018

Nebraska  
Motor Vehicle Dept.  
Elkhorn, NE

**Registration issued or renewed**

- Registration updated when owner moved the vehicle to a new location  
- Vehicle color noted as White

08/09/2018

136,477

2 Men and a Shop  
Bennington, NE  
402-238-3330  
2menandashop.com

 **5.0 / 5.0**

29 Verified Reviews

 **19** Customer Favorites



**Vehicle serviced**

- Maintenance inspection completed  
- Oil and filter changed  
- Drivability/performance checked  
- Air filter checked  
- Fluids checked  
- Tire condition and pressure checked  
- Body lubricated  
- Safety inspection performed

12/04/2018

140,469

Village Pointe Toyota  
Elkhorn, NE  
402-496-4444  
villagepointetoyota.com

 **4.2 / 5.0**

438 Verified Reviews

 **6,299** Customer Favorites



**Vehicle serviced**

- Cabin air filter replaced/cleaned  
- Air filter replaced  
- Light bulb(s) replaced  
- Fog light bulb(s) replaced

03/21/2019

144,106

Village Pointe Toyota  
Elkhorn, NE  
402-496-4444  
villagepointetoyota.com

 **4.2 / 5.0**

438 Verified Reviews

 **6,299** Customer Favorites



**Vehicle serviced**

- Maintenance inspection completed  
- Battery/charging system checked  
- Oil and filter changed

05/28/2019

Nebraska  
Motor Vehicle Dept.  
Elkhorn, NE

**Registration issued or renewed**

- Vehicle color noted as White

06/12/2019

147,141

2 Men and a Shop  
Bennington, NE  
402-238-3330  
2menandashop.com

 **5.0 / 5.0**

29 Verified Reviews

 **19** Customer Favorites



**Vehicle serviced**

06/14/2019

147,235

Village Pointe Toyota  
Elkhorn, NE  
402-496-4444  
villagepointetoyota.com

 **4.2 / 5.0**

438 Verified Reviews

 **6,299** Customer Favorites



**Vehicle serviced**

- Maintenance inspection completed  
- Battery/charging system checked

07/26/2019

149,341

Village Pointe Toyota  
Elkhorn, NE  
402-496-4444  
villagepointetoyota.com

 **4.2 / 5.0**



**Vehicle serviced**

- Maintenance inspection completed  
- Battery/charging system checked

438 Verified Reviews

♥ 6,299 Customer Favorites

08/12/2019 149,696

2 Men and a Shop  
Bennington, NE  
402-238-3330  
2menandashop.com

★ 5.0 / 5.0

29 Verified Reviews

♥ 19 Customer Favorites



**Vehicle serviced**

- Maintenance inspection completed
- Oil and filter changed
- Radiator checked
- Antifreeze/coolant flushed/changed
- Drivability/performance checked
- Air filter checked
- Fluids checked
- Tire condition and pressure checked
- Body lubricated

09/18/2019 151,895

Village Pointe Toyota  
Elkhorn, NE  
402-496-4444  
villagepointetoyota.com

★ 4.2 / 5.0

438 Verified Reviews

♥ 6,299 Customer Favorites



**Vehicle serviced**

- Oil and filter changed

10/21/2019 155,224

Village Pointe Toyota  
Elkhorn, NE  
402-496-4444  
villagepointetoyota.com

★ 4.2 / 5.0

438 Verified Reviews

♥ 6,299 Customer Favorites



**Vehicle serviced**

- Oil and filter changed
- Tires rotated

11/06/2019 156,445

Village Pointe Toyota  
Elkhorn, NE  
402-496-4444  
villagepointetoyota.com

★ 4.2 / 5.0

438 Verified Reviews

♥ 6,299 Customer Favorites



**Vehicle serviced**

- Maintenance inspection completed
- Battery/charging system checked
- Starter replaced

12/09/2019

Damage Report



**Accident reported: minor damage**

- Vehicle involved in a rear-end collision with another motor vehicle
- Damage to front
- Front center primarily damaged
- Airbags did not deploy



**Damage Severity Scale**

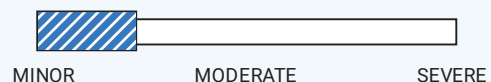

**Damage Location**

FRONT





## CARFAX HAS THE MOST ACCIDENT & DAMAGE INFORMATION

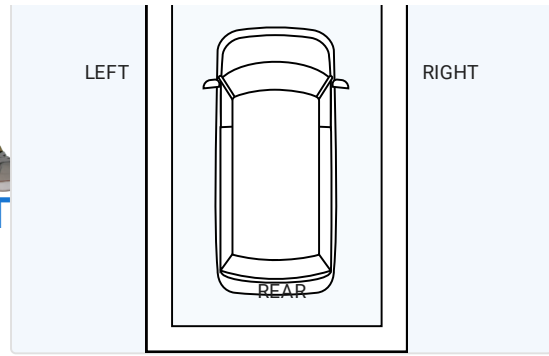



Minor damage is usually cosmetic, including dents or scratches to the vehicle body.







04/30/2020 Nebraska Motor Vehicle Dept. Elkhorn, NE **Registration issued or renewed**  
- Vehicle color noted as White

08/06/2020 162,000 Village Pointe Toyota Elkhorn, NE 402-496-4444 villagepointetoyota.com  
★ 4.2 / 5.0  
438 Verified Reviews  
❤️ 6,299 Customer Favorites **Vehicle serviced**  
- Oil and filter changed  
- Brake light bulb(s) replaced

 **Owner 2**  
Purchased: 2020

Personal Vehicle  
18,387 mi/yr

Date	Mileage	Source	Comments
10/05/2020	163,051	Nebraska Motor Vehicle Dept.	<b>Vehicle purchase reported</b>
01/14/2021		Nebraska Motor Vehicle Dept. Omaha, NE	<b>Title issued or updated</b> - Registration issued or renewed - New owner reported - Vehicle color noted as White
02/10/2021	166,313	Baxter Toyota La Vista La Vista, NE 402-731-2000 toyotaoflavista.com ★ 4.5 / 5.0 185 Verified Reviews ❤️ 153 Customer Favorites	 <b>Vehicle serviced</b> - Maintenance inspection completed - 5,000 mile service performed - Oil and filter changed - Tires rotated - Steering gear replaced - Rear shock absorber(s) replaced - Power steering hose(s)/line(s) replaced - Tire repaired
05/28/2021	173,320	Baxter Toyota La Vista La Vista, NE 402-731-2000 toyotaoflavista.com ★ 4.5 / 5.0 185 Verified Reviews ❤️ 153 Customer Favorites	 <b>Vehicle serviced</b> - Maintenance inspection completed - A/C compressor replaced

06/17/2021	174,441	Valvoline Instant Oil Change Omaha, NE 402-592-6550 vioc.com ★ 4.4 / 5.0 73 Verified Reviews ❤️ 115 Customer Favorites		<b>Vehicle serviced</b> - Oil and filter changed
07/31/2021	179,830	Walmart Auto Care Center Park Rapids, MN 218-732-0324 https://www.walmart.com ★ 4.9 / 5.0 15 Verified Reviews		<b>Vehicle serviced</b> - Tire repaired
08/09/2021	180,733	Baxter Toyota La Vista La Vista, NE 402-731-2000 toyotaoflavista.com ★ 4.5 / 5.0 185 Verified Reviews ❤️ 153 Customer Favorites		<b>Vehicle serviced</b> - Maintenance inspection completed - 5,000 mile service performed - Oil and filter changed - Tires rotated - Brake fluid flushed/changed - Brakes replaced - Front brake pads replaced - Brake rotor(s) resurfaced - Rear brake pads replaced - Rear brake rotor(s) replaced
09/28/2021	183,893	Walmart Auto Care Center Omaha, NE 402-697-1839 https://www.walmart.com ★ 4.5 / 5.0 17 Verified Reviews		<b>Vehicle serviced</b> - Tire repaired
11/04/2021	186,067	Baxter Toyota La Vista La Vista, NE 402-731-2000 toyotaoflavista.com ★ 4.5 / 5.0 185 Verified Reviews ❤️ 153 Customer Favorites		<b>Vehicle serviced</b> - Maintenance inspection completed - Fluids checked - Oil and filter changed
12/27/2021	189,345	Baxter Toyota La Vista La Vista, NE 402-731-2000 toyotaoflavista.com ★ 4.5 / 5.0 185 Verified Reviews ❤️ 153 Customer Favorites		<b>Vehicle serviced</b> - Maintenance inspection completed
02/22/2022		Nebraska Motor Vehicle Dept. Omaha, NE		<b>Registration issued or renewed</b> - Vehicle color noted as White
05/22/2022	195,098	Valvoline Instant Oil Change Omaha, NE 402-592-6550 vioc.com ★ 4.4 / 5.0		<b>Vehicle serviced</b> - Oil and filter changed - Cabin air filter replaced/cleaned

★ 4.4 / 5.0  
73 Verified Reviews  
❤️ 115 Customer Favorites

09/29/2022 199,524

Valvoline Instant Oil Change  
Omaha, NE  
402-592-6550  
vioc.com



**Vehicle serviced**

- Transmission fluid changed
- Cabin air filter replaced/cleaned
- Oil and filter changed

★ 4.4 / 5.0  
73 Verified Reviews  
❤️ 115 Customer Favorites

05/31/2023

Nebraska  
Motor Vehicle Dept.  
Omaha, NE

**Registration issued or renewed**

- Vehicle color noted as White

08/10/2023

Iowa  
Motor Vehicle Dept.  
Urbandale, IA  
Title #77BD61379

**Dealer took title of this vehicle while it was in inventory**

- Title or registration issued
- Vehicle color noted as White



**Glossary**

**Accident Indicator**

CARFAX receives information about accidents in all 50 states, the District of Columbia and Canada.

Not every accident is reported to CARFAX. As details about the accident become available, those additional details are added to the CARFAX Vehicle History Report. CARFAX recommends that you have this vehicle inspected by a qualified mechanic.

**Damage Severity**

Damage events result in one of the following severity levels:

- Minor: Generally, minor damage is cosmetic (including dents or scratches), may only require reconditioning, and typically does not compromise a vehicle's operation and/or safety.
- Moderate: Moderate damage may affect multiple components of the vehicle and may impair the vehicle's operation and/or safety.
- Severe: Severe damage usually affects multiple components of the vehicle and is likely to compromise the vehicle's operation and/or safety.

CARFAX recommends getting a pre-purchase inspection at a certified collision repair facility.

**First Owner**

When the first owner(s) obtains a title from a Department of Motor Vehicles as proof of ownership.

**New Owner Reported**

When a vehicle is sold to a new owner, the Title must be transferred to the new owner(s) at a Department of Motor Vehicles.

**Ownership History**

CARFAX defines an owner as an individual or business that possesses and uses a vehicle. Not all title transactions represent changes in ownership. To provide estimated number of owners, CARFAX proprietary technology analyzes all the events in a vehicle history. Estimated ownership is available for vehicles manufactured after 1991 and titled solely in the US including Puerto Rico. Dealers sometimes opt to take ownership of a vehicle and are required to in the following states: Maine, Massachusetts, New Jersey, Ohio, Oklahoma, Pennsylvania and South Dakota. Please consider this as you review a vehicle's estimated ownership history.

**Title Issued**

A state issues a title to provide a vehicle owner with proof of ownership. Each title has a unique number. Each title or registration record on a CARFAX report does not necessarily indicate a change in ownership. In Canada, a registration and bill of sale are used as proof of ownership.

**Toyota Recall / Service Campaign**

Portions of this report have been included under license from Toyota Motor North America, Inc. ("TOYOTA"), License Agreement TMS1013. This data applies only to vehicle marketed or originally sold in Mexico and the United States of America, including Guam, Saipan, American Samoa, Puerto Rico, the U.S. Virgin Islands and the other United States territories and protectorates with currently open safety or emissions recalls, or service campaigns. While TOYOTA provides data to Carfax Inc. on a regular basis,

this report may not include very recent activity. For the manufacturer's most current information on recall/campaign activity for any Toyota, Lexus or Scion brand vehicle, you must go to <http://toyota.com/recall> or <http://lexus.com/recall>.