



# Vehicle History Report™

US \$44.99

## 2014 TOYOTA SIENNA XLE 7-PASSENGER

VIN: 5TDDK3DC5ES080210  
VAN  
3.5L V6 F DOHC 24V  
GASOLINE  
ALL WHEEL DRIVE

Accident reported: minor to moderate damage

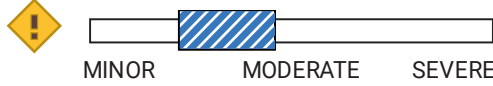

25 Service history records



CARFAX 1-Owner vehicle



Personal vehicle



137,265 Last reported odometer reading



## Ownership History

The number of owners is estimated

Owner 1

Year purchased

2014

Type of owner

Personal

Estimated length of ownership

9 yrs. 4 mo.

Owned in the following states/provinces

Minnesota

Estimated miles driven per year

15,257/yr

Last reported odometer reading

137,265



## Title History

CARFAX guarantees the information in this section

Owner 1

### Damage Brands

Salvage | Junk | Rebuilt | Fire | Flood | Hail | Lemon

Guaranteed  
No Problem

### Odometer Brands

Not Actual Mileage | Exceeds Mechanical Limits

Guaranteed  
No Problem



## Additional History

Not all accidents / issues are reported to CARFAX

Owner 1

### Total Loss



No total loss reported to CARFAX.

No Issues  
Reported

### Structural Damage

CARFAX recommends that you have this vehicle inspected by a collision repair specialist.

No Issues  
Reported

<b>Airbag Deployment</b> No airbag deployment reported to CARFAX.	 No Issues Reported
<b>Odometer Check</b> No indication of an odometer rollback.	 No Issues Indicated
<b>Accident / Damage</b> Accident reported: 05/13/2016. Damage reported: 04/26/2017 and 10/07/2019.	Accident Reported
<b>Manufacturer Recall</b> No open recalls reported to CARFAX. Check with an authorized Toyota dealer for any open recalls. View Toyota disclosure	 No Recalls Reported
<b>Basic Warranty</b> Original warranty estimated to have expired.	<b>Warranty Expired</b>











## Detailed History





### Owner 1

Purchased: 2014



Personal Vehicle  
15,257 mi/yr



Date	Mileage	Source	Comments
01/27/2014		NICB	<b>Vehicle manufactured and shipped to original dealer</b>
02/06/2014		Burnsville Toyota Burnsville, MN 952-435-8200 burnsvilletoyota.com  <b>4.6 / 5.0</b> 207 Verified Reviews  <b>237</b> Customer Favorites	<b>Vehicle offered for sale</b>
02/18/2014		Rudy Luther Toyota Scion Minneapolis, MN 763-222-2020 rudyluthertoyota.com/  <b>4.4 / 5.0</b> 260 Verified Reviews  <b>369</b> Customer Favorites	<b>Vehicle offered for sale</b>
03/06/2014	5	Rudy Luther Toyota Scion Minneapolis, MN 763-222-2020 rudyluthertoyota.com/  <b>4.4 / 5.0</b> 260 Verified Reviews  <b>369</b> Customer Favorites	 <b>Vehicle serviced</b> - Accessories installed - Vehicle washed/detailed
03/10/2014		Rudy Luther Toyota Scion Minneapolis, MN 763-222-2020 rudyluthertoyota.com/ 	<b>Vehicle sold</b>

 **4.4 / 5.0**  
260 Verified Reviews  
 **369** Customer Favorites



03/10/2014 30 Minnesota  
Motor Vehicle Dept. **Vehicle purchase reported**  
- Titled or registered as personal vehicle



03/27/2014 Minnesota  
Motor Vehicle Dept.  
Minneapolis, MN  
Title #FL086B219 **Title or registration issued**  
- First owner reported  
- Loan or lien reported  
- Vehicle color noted as White



06/27/2014 5,208 Rudy Luther Toyota Scion  
Minneapolis, MN  
763-222-2020  
rudyluthertoyota.com/  **Vehicle serviced**  
- Recommended maintenance performed  
- 5,000 mile service performed  
- Oil and filter changed  
 **4.4 / 5.0**  
260 Verified Reviews  
 **369** Customer Favorites

11/24/2014 9,893 Rudy Luther Toyota Scion  
Minneapolis, MN  
763-222-2020  
rudyluthertoyota.com/  **Vehicle serviced**  
- Recommended maintenance performed  
- 10,000 mile service performed  
- Oil and filter changed  
 **4.4 / 5.0**  
260 Verified Reviews  
 **369** Customer Favorites

02/03/2015 Minnesota  
Motor Vehicle Dept.  
Minneapolis, MN  
Title #FL086B219 **Registration issued or renewed**  
- Loan or lien reported  
- Vehicle color noted as White

06/08/2015 15,339 Rudy Luther Toyota Scion  
Minneapolis, MN  
763-222-2020  
rudyluthertoyota.com/  **Vehicle serviced**  
- Recommended maintenance performed  
 **4.4 / 5.0**  
260 Verified Reviews  
 **369** Customer Favorites

07/06/2015 16,691 Rudy Luther Toyota Scion  
Minneapolis, MN  
763-222-2020  
rudyluthertoyota.com/  **Vehicle serviced**  
- Tire repaired  
 **4.4 / 5.0**  
260 Verified Reviews  
 **369** Customer Favorites

09/04/2015 20,799 Rudy Luther Toyota Scion  
Minneapolis, MN  
763-222-2020  
rudyluthertoyota.com/  **Vehicle serviced**  
 **4.4 / 5.0**  
260 Verified Reviews  
 **369** Customer Favorites

02/17/2016 Minnesota **Registration issued or renewed**

Motor Vehicle Dept.  
Minneapolis, MN  
Title #FL086B219

- Loan or lien reported  
- Vehicle color noted as White

03/10/2016 25,989

Rudy Luther Toyota Scion  
Minneapolis, MN  
763-222-2020  
rudyluthertoyota.com/



**Vehicle serviced**

★ 4.4 / 5.0

260 Verified Reviews

♥ 369 Customer Favorites

05/13/2016

Damage Report



**Accident reported: minor to moderate damage with another motor vehicle**

- Damage to front  
- Airbags did not deploy



**CARFAX HAS THE MOST  
ACCIDENT & DAMAGE  
INFORMATION**

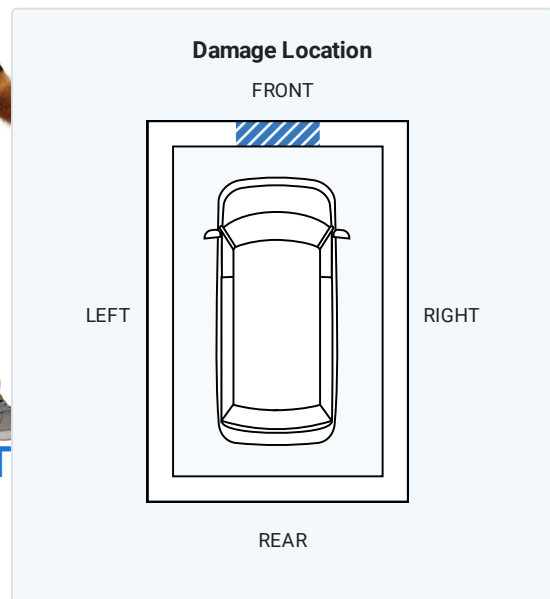
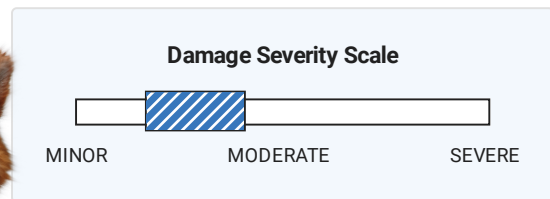

08/29/2016 31,895

Rudy Luther Toyota Scion  
Minneapolis, MN  
763-222-2020  
rudyluthertoyota.com/



**Vehicle serviced**

★ 4.4 / 5.0

260 Verified Reviews

♥ 369 Customer Favorites

09/22/2016 32,487

Rudy Luther Toyota Scion  
Minneapolis, MN  
763-222-2020  
rudyluthertoyota.com/



**Vehicle serviced**

★ 4.4 / 5.0

260 Verified Reviews

♥ 369 Customer Favorites

02/01/2017

Minnesota

Registration issued or renewed

02/01/2017

MINNESOTA

REGISTRATION ISSUED OR RENEWED

Motor Vehicle Dept.  
Minneapolis, MN  
Title #FL086B219

- Loan or lien reported
- Vehicle color noted as White

03/01/2017 37,306

Rudy Luther Toyota Scion  
Minneapolis, MN  
763-222-2020  
rudyluthertoyota.com/



**Vehicle serviced**

- 35,000 mile service performed
- Air filter replaced
- Cabin air filter replaced/cleaned
- Rear differential serviced
- Transfer case fluid flushed/changed
- Transfer case serviced
- Brakes checked
- Exterior light bulb(s) replaced

★ 4.4 / 5.0  
260 Verified Reviews  
❤️ 369 Customer Favorites

04/26/2017

Damage Report



**Damage reported: minor damage**

- Damage to front
- Damage to right front



**CARFAX HAS THE MOST ACCIDENT & DAMAGE INFORMATION**

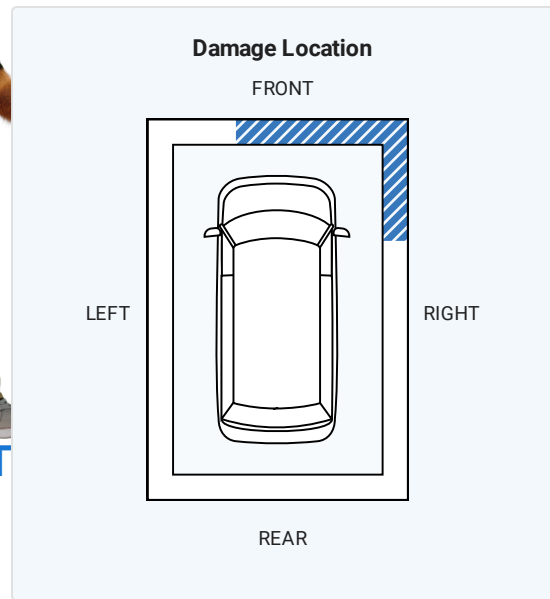
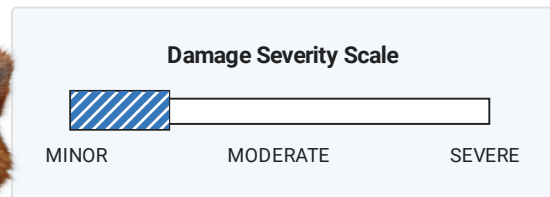

06/19/2017 43,398

Rudy Luther Toyota Scion  
Minneapolis, MN  
763-222-2020  
rudyluthertoyota.com/



**Vehicle serviced**

- 40,000 mile service performed

★ 4.4 / 5.0  
260 Verified Reviews  
❤️ 369 Customer Favorites

07/20/2017 45,452







Golden Valley Tire & Service  
Golden Valley, MN  
763-541-0569  
goldenvalltire.com



**Vehicle serviced**

- Four tires mounted
- Two wheel alignment performed
- Alignment performed
- Tire condition and pressure checked
- Wheel lug nuts torqued

★ 4.9 / 5.0  
102 Verified Reviews  
❤️ 804 Customer Favorites

10/25/2017	49,122	Rudy Luther Toyota Scion Minneapolis, MN 763-222-2020 rudyluthertoyota.com/ ★ 4.4 / 5.0 260 Verified Reviews ❤️ 369 Customer Favorites		<b>Vehicle serviced</b>
01/29/2018	52,901	Valvoline Instant Oil Change Plymouth, MN 763-544-2909 vioc.com ★ 4.7 / 5.0 82 Verified Reviews ❤️ 136 Customer Favorites		<b>Vehicle serviced</b> - Oil and filter changed
02/08/2018		Minnesota Motor Vehicle Dept. Minneapolis, MN Title #FL086B219		<b>Title or registration issued</b> - Loan or lien reported - Vehicle color noted as White
07/30/2018	65,139	Rudy Luther Toyota Scion Minneapolis, MN 763-222-2020 rudyluthertoyota.com/ ★ 4.4 / 5.0 260 Verified Reviews ❤️ 369 Customer Favorites		<b>Vehicle serviced</b> - Front brake rotor(s) resurfaced - Front brake pads replaced - Front brakes replaced - Front brake rotor(s) replaced
01/07/2019	70,823	Rudy Luther Toyota Scion Minneapolis, MN 763-222-2020 rudyluthertoyota.com/ ★ 4.4 / 5.0 260 Verified Reviews ❤️ 369 Customer Favorites		<b>Vehicle serviced</b>
01/23/2019		Minnesota Motor Vehicle Dept. Minneapolis, MN Title #FL086B219		<b>Title or registration issued</b> - Loan or lien reported - Vehicle color noted as White
05/24/2019	76,302	Rudy Luther Toyota Scion Minneapolis, MN 763-222-2020 rudyluthertoyota.com/ ★ 4.4 / 5.0 260 Verified Reviews ❤️ 369 Customer Favorites		<b>Vehicle serviced</b> - Recommended maintenance performed - 75,000 mile service performed - Brakes checked - Floor mat(s) checked - Battery replaced
10/07/2019	81,884	Rudy Luther Toyota Scion Minneapolis, MN 763-222-2020 rudyluthertoyota.com/ ★ 4.4 / 5.0 260 Verified Reviews ❤️ 369 Customer Favorites		<b>Vehicle serviced</b> - Maintenance inspection completed - 80,000 mile service performed - Tire condition and pressure checked - Brakes checked - Floor mat(s) checked

10/07/2019

Damage Report



**Damage reported: minor damage**  
- Damage to front



**CARFAX HAS THE MOST ACCIDENT & DAMAGE INFORMATION**

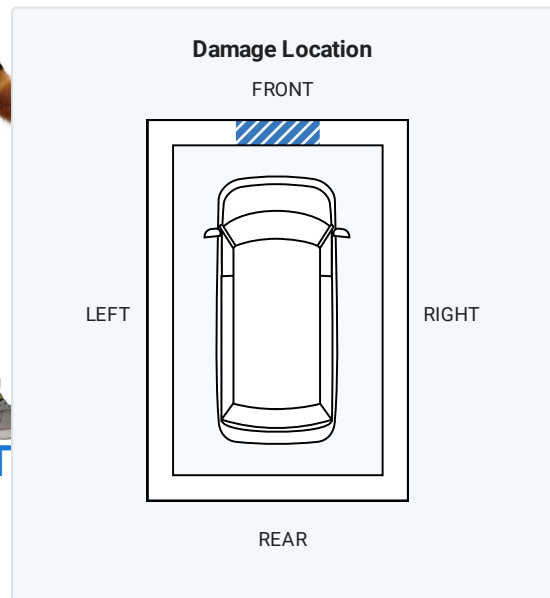
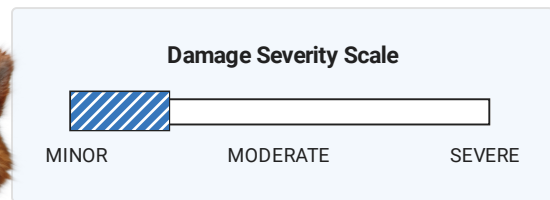

01/22/2020

Minnesota  
Motor Vehicle Dept.  
Minneapolis, MN  
Title #FL086B219

**Title or registration issued**  
- Loan or lien reported  
- Vehicle color noted as White

01/29/2020 87,207

Valvoline Instant Oil Change  
Plymouth, MN  
763-544-2909  
vioc.com



**Vehicle serviced**  
- Oil and filter changed  
- Air filter replaced

★ 4.7 / 5.0

82 Verified Reviews

♥ 136 Customer Favorites

04/22/2020 90,365

Golden Valley Tire & Service  
Golden Valley, MN  
763-541-0569  
goldenvalltires.com



**Vehicle serviced**  
- Alignment checked  
- Tire condition and pressure checked  
- Four tires mounted  
- Tires rotated  
- Wheel lug nuts torqued

★ 4.9 / 5.0

102 Verified Reviews

♥ 804 Customer Favorites

07/09/2020





Minnesota  
Motor Vehicle Dept.  
Minneapolis, MN  
Title #0003P6Q-1

**Title or registration issued**  
- Loan or lien reported  
- Vehicle color noted as White

10/20/2020

Minnesota  
Motor Vehicle Dept.  
Minneapolis, MN  
Title #0003P6Q-1

**Title or registration issued**  
- Loan or lien reported  
- Vehicle color noted as White

01/19/2021	99,488	Valvoline Instant Oil Change Plymouth, MN 763-544-2909 vioc.com ★ 4.7 / 5.0 82 Verified Reviews ❤️ 136 Customer Favorites		<b>Vehicle serviced</b> - Oil and filter changed
01/22/2021		Minnesota Motor Vehicle Dept. Minneapolis, MN Title #0003P6Q-1		<b>Title or registration issued</b> - Vehicle color noted as White
05/05/2021	105,216	Rudy Luther Toyota Scion Minneapolis, MN 763-222-2020 rudyluthertoyota.com/ ★ 4.4 / 5.0 260 Verified Reviews ❤️ 369 Customer Favorites		<b>Vehicle serviced</b> - Inspection performed - Tire checked - Maintenance inspection completed - Recommended maintenance performed - Floor mat(s) checked - Antifreeze/coolant flushed/changed - Transmission fluid changed - Brakes checked
08/03/2021	110,439	Oil X Change Buffalo, WY 307-620-9183 ★ 5.0 / 5.0 19 Verified Reviews ❤️ 10 Customer Favorites		<b>Vehicle serviced</b> - Recommended maintenance performed - Oil and filter changed
10/29/2021	116,346	Rudy Luther Toyota Scion Minneapolis, MN 763-222-2020 rudyluthertoyota.com/ ★ 4.4 / 5.0 260 Verified Reviews ❤️ 369 Customer Favorites		<b>Vehicle serviced</b> - Maintenance inspection completed - Recommended maintenance performed - Transfer case fluid flushed/changed - Transfer case serviced - Rear differential fluid flushed/changed - Rear differential serviced - Tire condition and pressure checked - Tires rotated - Oil and filter changed - Fluids checked - Cabin air filter replaced/cleaned - Brakes checked
01/20/2022		Minnesota Motor Vehicle Dept. Minneapolis, MN Title #0003P6Q-1		<b>Title issued or updated</b> - Registration issued or renewed - Vehicle color noted as White
01/03/2023		Minnesota Motor Vehicle Dept. Minneapolis, MN Title #0003P6Q-1		<b>Title issued or updated</b> - Registration issued or renewed - Vehicle color noted as White
03/06/2023	137,265	Valvoline Instant Oil Change Plymouth, MN 763-544-2909 vioc.com ★ 4.7 / 5.0		<b>Vehicle serviced</b> - Oil and filter changed



82 Verified Reviews

 136 Customer Favorites



## Glossary

### Accident Indicator

CARFAX receives information about accidents in all 50 states, the District of Columbia and Canada.

Not every accident is reported to CARFAX. As details about the accident become available, those additional details are added to the CARFAX Vehicle History Report. CARFAX recommends that you have this vehicle inspected by a qualified mechanic.

### Damage Indicator

Damage can be a result of many different types of events. Examples include contact with objects (other cars, trees, traffic signs, road debris, etc), vandalism, or weather-related events. Not every damage event is reported to CARFAX. As details about the damage event become available, those additional details are added to the CARFAX Vehicle History Report. CARFAX recommends that you have this vehicle inspected by a qualified mechanic.

### Damage Severity

Damage events result in one of the following severity levels:

- **Minor:** Generally, minor damage is cosmetic (including dents or scratches), may only require reconditioning, and typically does not compromise a vehicle's operation and/or safety.
- **Moderate:** Moderate damage may affect multiple components of the vehicle and may impair the vehicle's operation and/or safety.
- **Severe:** Severe damage usually affects multiple components of the vehicle and is likely to compromise the vehicle's operation and/or safety.

CARFAX recommends getting a pre-purchase inspection at a certified collision repair facility.

### First Owner

When the first owner(s) obtains a title from a Department of Motor Vehicles as proof of ownership.

### Ownership History

CARFAX defines an owner as an individual or business that possesses and uses a vehicle. Not all title transactions represent changes in ownership. To provide estimated number of owners, CARFAX proprietary technology analyzes all the events in a vehicle history. Estimated ownership is available for vehicles manufactured after 1991 and titled solely in the US including Puerto Rico. Dealers sometimes opt to take ownership of a vehicle and are required to in the following states: Maine, Massachusetts, New Jersey, Ohio, Oklahoma, Pennsylvania and South Dakota. Please consider this as you review a vehicle's estimated ownership history.

### Title Issued

A state issues a title to provide a vehicle owner with proof of ownership. Each title has a unique number. Each title or registration record on a CARFAX report does not necessarily indicate a change in ownership. In Canada, a registration and bill of sale are used as proof of ownership.

### Toyota Recall / Service Campaign

Portions of this report have been included under license from Toyota Motor North America, Inc. ("TOYOTA"), License Agreement TMS1013. This data applies only to vehicle marketed or originally sold in Mexico and the United States of America, including Guam, Saipan, American Samoa, Puerto Rico, the U.S. Virgin Islands and the other United States territories and protectorates with currently open safety or emissions recalls, or service campaigns. While TOYOTA provides data to Carfax Inc. on a regular basis, this report may not include very recent activity. For the manufacturer's most current information on recall/campaign activity for any Toyota, Lexus or Scion brand vehicle, you must go to <http://toyota.com/recall> or <http://lexus.com/recall>.