



# Vehicle History Report™

US \$44.99

## 2012 CHRYSLER TOWN AND COUNTRY TOURING

VIN: 2C4RC1BG5CR194596  
VAN  
3.6L V6 F DOHC 24V  
GASOLINE  
FRONT WHEEL DRIVE

Damage reported: minor damage

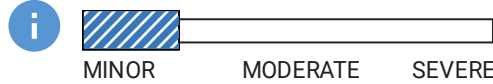

16 Service history records

At least 1 open recall

2 Previous owners

65,991 Last reported odometer reading

## CARFAX Ownership History

The number of owners is estimated

	Owner 1	Owner 2
Year purchased	2012	2021
Type of owner	Personal lease	Personal
Estimated length of ownership	8 yrs. 4 mo.	2 yrs. 4 mo.
Owned in the following states/provinces	Minnesota, Wisconsin	Wisconsin
Estimated miles driven per year	7,653/yr	4,427/yr
Last reported odometer reading	51,248	65,991

## CARFAX Title History

CARFAX guarantees the information in this section

	Owner 1	Owner 2
<b>Damage Brands</b> Salvage   Junk   Rebuilt   Fire   Flood   Hail   Lemon	<b>Guaranteed</b> No Problem	<b>Guaranteed</b> No Problem
<b>Odometer Brands</b> Not Actual Mileage   Exceeds Mechanical Limits	<b>Guaranteed</b> No Problem	<b>Guaranteed</b> No Problem

## CARFAX Additional History

Not all accidents / issues are reported to CARFAX

	Owner 1	Owner 2
<b>Total Loss</b> No total loss reported to CARFAX.	No Issues Reported	No Issues Reported
<b>Structural Damage</b>	No Issues	No Issues

CARFAX recommends that you have this vehicle inspected by a collision repair specialist.	— Reported	— Reported
<b>Airbag Deployment</b> No airbag deployment reported to CARFAX.	✓ No Issues Reported	✓ No Issues Reported
<b>Odometer Check</b> No indication of an odometer rollback.	✓ No Issues Indicated	✓ No Issues Indicated
<b>Accident / Damage</b> Damage reported: 12/06/2022.	✓ No Issues Reported	Minor Damage
<b>Manufacturer Recall</b> At least 1 manufacturer recall requires repair.	Recall Reported	No New Recalls Reported
<b>Basic Warranty</b> Original warranty estimated to have expired.	Warranty Expired	Warranty Expired





## Detailed History

 **Owner 1**  
Purchased: 2012



**Low mileage!** This owner drove less than the industry average of 15,000 miles per year.

Personal Lease Vehicle  
7,653 mi/yr

Date	Mileage	Source		Comments
12/01/2011		Ubersox Chrysler of Iowa County Barneveld, WI 608-924-1505 iowacountychrysler.com		<b>Vehicle offered for sale</b>
12/14/2011	12	Ubersox Chrysler of Iowa County Barneveld, WI 608-924-1505 iowacountychrysler.com		<b>Vehicle serviced</b> - Pre-delivery inspection completed - Recommended maintenance performed
12/14/2011		Service Facility		<b>Vehicle serviced</b>
03/28/2012		Service Facility		<b>Vehicle serviced</b>
03/29/2012		Ubersox Chrysler of Iowa County Barneveld, WI 608-924-1505 iowacountychrysler.com		<b>Vehicle serviced</b>
05/28/2012		Ubersox Chrysler of Iowa County Barneveld, WI 608-924-1505 iowacountychrysler.com		<b>Vehicle sold</b>
09/06/2012	3,799	Valvoline Instant Oil Change Lakeville, MN		<b>Vehicle serviced</b> - Oil and filter changed

952-892-5507  
vioc.com

★ 4.6 / 5.0

77 Verified Reviews

♥ 125 Customer Favorites

09/17/2012

Minnesota  
Motor Vehicle Dept.  
Lakeville, MN  
Title #B1780Q306

**Registration issued or renewed**

- Titled or registered as personal lease vehicle
- Loan or lien reported
- Vehicle color noted as Red

11/12/2012 5,071

Wisconsin  
Motor Vehicle Dept.  
Wausau, WI

**Odometer reading reported**

11/19/2012

Wisconsin  
Motor Vehicle Dept.  
Wausau, WI  
Title #12324M20053

**Title issued or updated**

- Registration issued or renewed
- First owner reported

04/13/2013 11,387

Brickner's of Wausau, Inc.  
Wausau, WI  
715-842-4646  
bricknersofwausau.net



**Vehicle serviced**

- Maintenance inspection completed
- Oil and filter changed
- Maintenance reminder reset
- Steering/suspension checked

★ 4.7 / 5.0

117 Verified Reviews

♥ 72 Customer Favorites

07/04/2013

Wisconsin  
Motor Vehicle Dept.  
Wausau, WI

**Registration issued or renewed**

11/05/2013 17,274

Sears Auto Center



**Vehicle serviced**

- Battery replaced

06/11/2014

FCA US LLC

**Manufacturer Safety recall issued**

- NHTSA #14V-234
- Recall #P25 REAR QUARTER VENT WINDOW SWITCH
- Status: Remedy available

Click here for a copy of the owner letter for this Recall or call 1- 800-853-1403 if you have any questions or need additional information on this recall.

⊕ **Learn more about this recall**

07/03/2014

Wisconsin  
Motor Vehicle Dept.  
Wausau, WI

**Registration issued or renewed**

08/07/2014 20,673

Brickner's of Wausau, Inc.  
Wausau, WI  
715-842-4646  
bricknersofwausau.net





**Vehicle serviced**



- Battery replaced
- Electrical system checked

★ 4.7 / 5.0

117 Verified Reviews

♥ 72 Customer Favorites

06/04/2015		Wisconsin Motor Vehicle Dept. Wausau, WI		<b>Registration issued or renewed</b>
06/10/2016		Wisconsin Motor Vehicle Dept. Wausau, WI		<b>Registration issued or renewed</b>
06/12/2017		Wisconsin Motor Vehicle Dept. Wausau, WI		<b>Registration issued or renewed</b>
07/10/2017	42,095	Service Facility		<b>Vehicle serviced</b> - Tire(s) balanced - Tires rotated
06/11/2018		Wisconsin Motor Vehicle Dept. Wausau, WI		<b>Registration issued or renewed</b>
05/28/2019	51,248	Sam's Club Tire & Battery Center Wausau, WI 715-359-0044 <a href="https://www.samsclub.com">https://www.samsclub.com</a>		<b>Vehicle serviced</b> - Tire(s) balanced - Tires rotated
06/06/2019		Wisconsin Motor Vehicle Dept. Wausau, WI		<b>Registration issued or renewed</b>
06/05/2020		Wisconsin Motor Vehicle Dept. Wausau, WI		<b>Registration issued or renewed</b>

 <b>Owner 2</b> Purchased: 2021		<b>Low mileage!</b> This owner drove less than the industry average of 15,000 miles per year.	Personal Vehicle 4,427 mi/yr
---	---	---	---------------------------------

Date	Mileage	Source		Comments
01/23/2021	55,934	Wisconsin Motor Vehicle Dept. Schofield, WI		<b>Odometer reading reported</b>
02/08/2021		Wisconsin Motor Vehicle Dept. Schofield, WI Title #21039FK0165		<b>Title issued or updated</b> - Registration issued or renewed - New owner reported - Loan or lien reported
03/04/2021	55,972	Griesbach Auto Service Schofield, WI 715-355-1553 <a href="http://griesbachautoservice.com">griesbachautoservice.com</a> ★ <b>4.8 / 5.0</b> 8 Verified Reviews ❤️ <b>8</b> Customer Favorites		<b>Vehicle serviced</b>
03/16/2021	56,128	Griesbach Auto Service		<b>Vehicle serviced</b>

Schofield, WI  
715-355-1553  
griesbachautoservice.com



★ 4.8 / 5.0

8 Verified Reviews

♥ 8 Customer Favorites

04/22/2021 56,579

Griesbach Auto Service  
Schofield, WI  
715-355-1553  
griesbachautoservice.com



**Vehicle serviced**

- Radiator hose clamp replaced

★ 4.8 / 5.0

8 Verified Reviews

♥ 8 Customer Favorites

07/21/2021 58,278

Griesbach Auto Service  
Schofield, WI  
715-355-1553  
griesbachautoservice.com



**Vehicle serviced**

- Fluids checked  
- Oil and filter changed  
- Tire condition and pressure checked  
- Brakes replaced  
- Rear brake rotor(s) replaced  
- Rear brakes replaced

★ 4.8 / 5.0

8 Verified Reviews

♥ 8 Customer Favorites

09/18/2021

Wisconsin  
Motor Vehicle Dept.  
Schofield, WI

**Registration issued or renewed**

02/10/2022 62,231

Griesbach Auto Service  
Schofield, WI  
715-355-1553  
griesbachautoservice.com



**Vehicle serviced**

- Thermostat replaced  
- Antifreeze/coolant flushed/changed  
- Drive belts checked

★ 4.8 / 5.0

8 Verified Reviews

♥ 8 Customer Favorites

05/03/2022 63,574

Auto Select Weston Express  
Schofield, WI  
715-355-4050  
autoselectonline.com



**Vehicle serviced**

★ 4.6 / 5.0

38 Verified Reviews

♥ 13 Customer Favorites

12/06/2022

Damage Report



**Damage reported: minor damage**

- Damage to front  
- Damage to right front



**Damage Severity Scale**

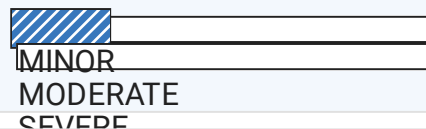

**Damage Location**

FRONT



**CARFAX HAS THE MOST  
ACCIDENT & DAMAGE  
INFORMATION**

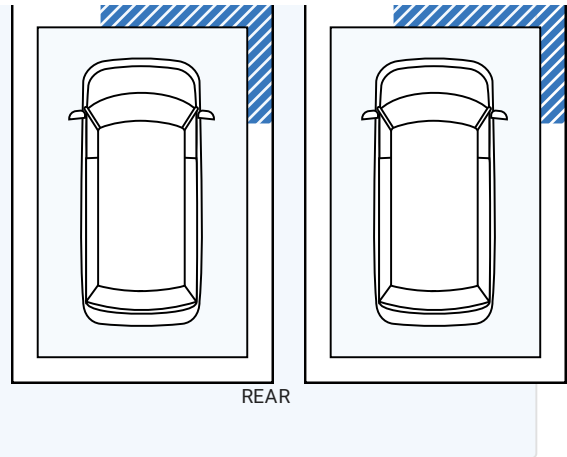

Minor damage is usually cosmetic, including dents or scratches to the vehicle body.

12/06/2022		Wisconsin Motor Vehicle Dept. Schofield, WI	<b>Registration issued or renewed</b>
05/02/2023	65,991	Wisconsin Motor Vehicle Dept. Wausau, WI	<b>Odometer reading reported</b>
05/08/2023		Wisconsin Motor Vehicle Dept. Wausau, WI Title #2312805720181	<b>Title issued or updated</b> - Vehicle repossessed



## Glossary

### Damage Indicator

Damage can be a result of many different types of events. Examples include contact with objects (other cars, trees, traffic signs, road debris, etc), vandalism, or weather-related events. Not every damage event is reported to CARFAX. As details about the damage event become available, those additional details are added to the CARFAX Vehicle History Report. CARFAX recommends that you have this vehicle inspected by a qualified mechanic.

### Damage Severity

Damage events result in one of the following severity levels:

- **Minor:** Generally, minor damage is cosmetic (including dents or scratches), may only require reconditioning, and typically does not compromise a vehicle's operation and/or safety.
- **Moderate:** Moderate damage may affect multiple components of the vehicle and may impair the vehicle's operation and/or safety.
- **Severe:** Severe damage usually affects multiple components of the vehicle and is likely to compromise the vehicle's operation and/or safety.

CARFAX recommends getting a pre-purchase inspection at a certified collision repair facility.

### First Owner

When the first owner(s) obtains a title from a Department of Motor Vehicles as proof of ownership.

### Manufacturer Recall

Automobile manufacturers issue recall notices to inform vehicle owners of a safety defect or failure to meet minimum federal safety or emissions standards. Manufacturer recalls are repaired at no cost to the customer.

### New Owner Reported

When a vehicle is sold to a new owner, the Title must be transferred to the new owner(s) at a Department of Motor Vehicles.

### Ownership History

CARFAX defines an owner as an individual or business that possesses and uses a vehicle. Not all title transactions represent changes in ownership. To provide estimated number of owners, CARFAX proprietary technology analyzes all the events in a vehicle history. Estimated ownership is available for vehicles manufactured after 1991 and titled solely in the US including Puerto Rico. Dealers sometimes opt to take ownership of a vehicle and are required to in the following states: Maine, Massachusetts, New Jersey, Ohio, Oklahoma, Pennsylvania and South Dakota. Please consider this as you review a vehicle's estimated ownership history.

**Repossession**

When a repossession occurs a vehicle owner fails to make loan payments, and the financial institution holding the title takes possession of the vehicle.

**Title Issued**

A state issues a title to provide a vehicle owner with proof of ownership. Each title has a unique number. Each title or registration record on a CARFAX report does not necessarily indicate a change in ownership. In Canada, a registration and bill of sale are used as proof of ownership.